

## Operating Instructions

### DVD Video Recorder

Model No. **DMR-T6070**

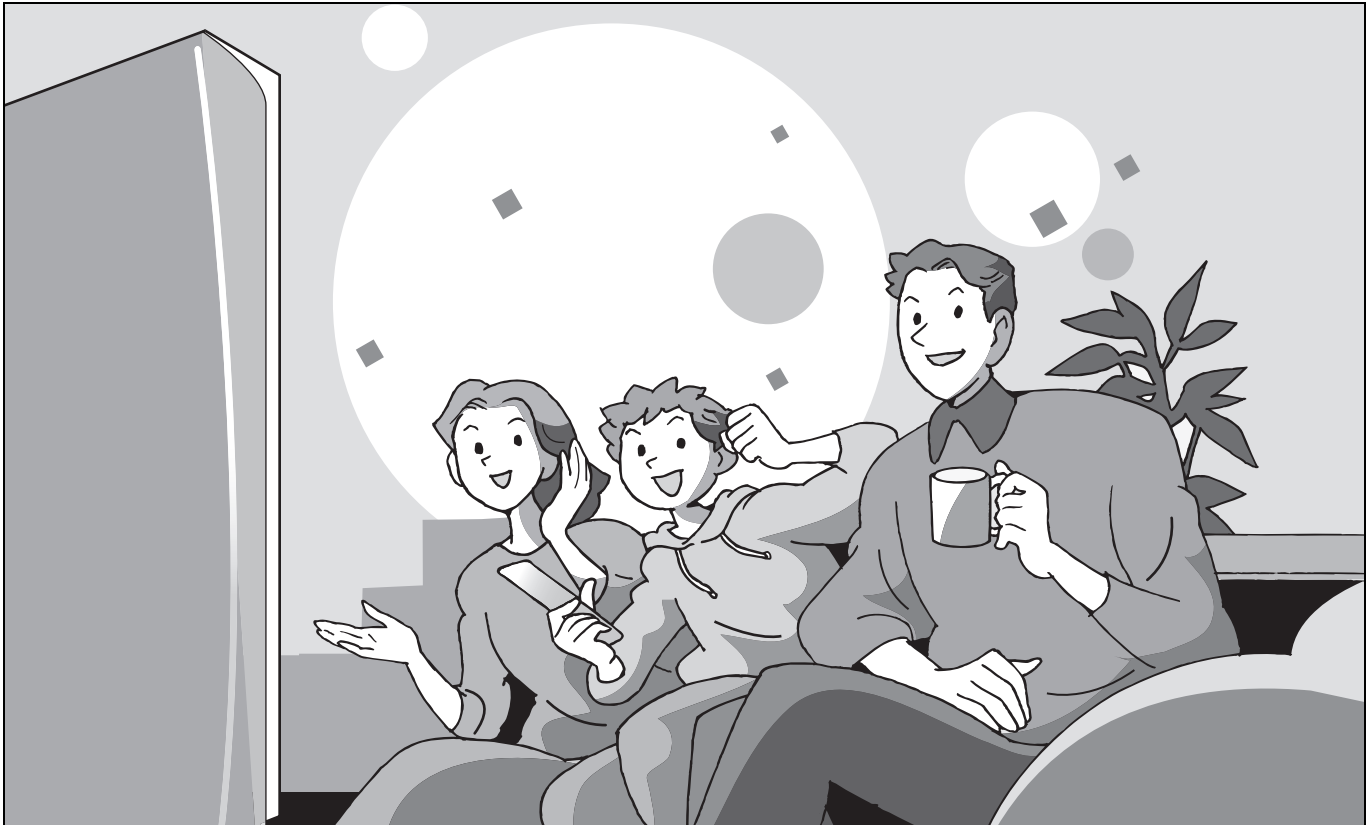

### Dear customer

Thank you for purchasing this product. For optimum performance and safety, please read these instructions carefully.

Before connecting, operating or adjusting this product, please read these instructions completely.  
Please keep this manual for future reference.

#### Region number supported by this unit

Region numbers are allocated to DVD players and software according to where they are sold.

- The region number of this unit is "1".
- The unit will play DVDs marked with labels containing "1" or "ALL".

Example:



The warranty can be found on page 63.



This manual was printed with soy based ink.

**CAUTION!**

THIS PRODUCT UTILIZES A LASER.  
USE OF CONTROLS OR ADJUSTMENTS OR PERFORMANCE OF PROCEDURES OTHER THAN THOSE SPECIFIED HEREIN MAY RESULT IN HAZARDOUS RADIATION EXPOSURE. DO NOT OPEN COVERS AND DO NOT REPAIR YOURSELF. REFER SERVICING TO QUALIFIED PERSONNEL.

**WARNING:**

TO REDUCE THE RISK OF FIRE, ELECTRIC SHOCK OR PRODUCT DAMAGE, DO NOT EXPOSE THIS APPARATUS TO RAIN, MOISTURE, DRIPPING OR SPLASHING AND THAT NO OBJECTS FILLED WITH LIQUIDS, SUCH AS VASES, SHALL BE PLACED ON THE APPARATUS.

**Note to CATV system installer:**

This reminder is provided to call the CATV system installer's attention to Article 820-40 of the NEC that provides guidelines for proper grounding and, in particular, specifies that the cable ground shall be connected to the grounding system of the building, as close to the point of cable entry as practical.

DANGER	- VISIBLE AND INVISIBLE LASER RADIATION WHEN OPEN. AVOID DIRECT EXPOSURE TO BEAM. (FDA 21 CFR)
CAUTION	- VISIBLE AND INVISIBLE LASER RADIATION WHEN OPEN. AVOID EXPOSURE TO BEAM. (IEC60825-1)
ATTENTION	- RAYONNEMENT LASER VISIBLE ET INVISIBLE EN CAS D'OUVERTURE. EXPOSITION DANGEREUSE AU FASCEAU.
ADVARSEL	- SYNLIG OG USYNLIG LASERSTRÅLING VED ÅBNING. UDGÅ UDSÆTTELSE FOR STRÅLING.
VARO!	- AVATTAESSA OLET ALTIINNA NÄKYVÄÄ JA NÄKYMÄTÖN LASERSÄTEILYLLÄ. ÄLÄ KATSO SÄTEESEEN.
VARNING	- SYNLIG OCH OSYNLIG LASERSTRÅLNING NÄR DENNA DEL ÄR ÖPPNAD. BETRÄKTA EJ STRÅLEN.
ADVARSEL	- SYNLIG OG USYNLIG LASERSTRÅLING NÄR DEKSEL ÅPNES. UNGÅ EKSPONERING FOR STRÅLEN.
VORSICHT	- SICHTBARE UND UNSICHTBARE LASERSTRÄHLUNG, WENN ABDECKUNG GEÖFFNET. NICHT DEM STRAHL AUSSETZEN.
注意	- 打开时有可见及不可见激光辐射。避免激光束照射。
注意	- ここを開くと可視及び不可視のレーザー光が出ます。ヒームを直接見たり、触れたりしないでください。 RQLS0233

(Inside of product)

**CAUTION!**

DO NOT INSTALL OR PLACE THIS UNIT IN A BOOKCASE, BUILT-IN CABINET OR IN ANOTHER CONFINED SPACE. ENSURE THE UNIT IS WELL VENTILATED. TO PREVENT RISK OF ELECTRIC SHOCK OR FIRE HAZARD DUE TO OVERHEATING, ENSURE THAT CURTAINS AND ANY OTHER MATERIALS DO NOT OBSTRUCT THE VENTILATION VENTS.

Keep the small memory cards such as the SD Memory Card out of reach of children. If swallowed, seek medical advice immediately.

The socket outlet shall be installed near the equipment and easily accessible or the mains plug or an appliance coupler shall remain readily operable.

WARNING: The apparatus shall be connected to a mains socket outlet with a protective earthing connection.



**CAUTION**

**RISK OF ELECTRIC SHOCK**

**DO NOT OPEN**



CAUTION: TO REDUCE THE RISK OF ELECTRIC SHOCK, DO NOT REMOVE SCREWS. NO USER-SERVICEABLE PARTS INSIDE. REFER SERVICING TO QUALIFIED SERVICE PERSONNEL.



The lightning flash with arrowhead symbol, within an equilateral triangle, is intended to alert the user to the presence of uninsulated "dangerous voltage" within the product's enclosure that may be of sufficient magnitude to constitute a risk of electric shock to persons.



The exclamation point within an equilateral triangle is intended to alert the user to the presence of important operating and maintenance (servicing) instructions in the literature accompanying the appliance.

**FCC Note:**

This equipment has been tested and found to comply with the limits for a Class B digital device, pursuant to Part 15 of the FCC Rules. These limits are designed to provide reasonable protection against harmful interference in a residential installation. This equipment generates, uses, and can radiate radio frequency energy and, if not installed and used in accordance with the instructions, may cause harmful interference to radio communications. However, there is no guarantee that interference will not occur in a particular installation. If this equipment does cause harmful interference to radio or television reception, which can be determined by turning the equipment off and on, the user is encouraged to try to correct the interference by one or more of the following measures:

- Reorient or relocate the receiving antenna.
- Increase the separation between the equipment and receiver.
- Connect the equipment into an outlet on a circuit different from that to which the receiver is connected.
- Consult the dealer or an experienced radio/TV technician for help.

FCC Caution: To assure continued compliance, follow the attached installation instructions and use only shielded interface cables when connecting to peripheral devices. Any changes or modifications not expressly approved by the party responsible for compliance could void the user's authority to operate this equipment.

This device complies with Part 15 of the FCC Rules. Operation is subject to the following two conditions: (1) This device may not cause harmful interference, and (2) this device must accept any interference received, including interference that may cause undesired operation.

## IMPORTANT SAFETY INSTRUCTIONS

Read these operating instructions carefully before using the unit. Follow the safety instructions on the unit and the applicable safety instructions listed below. Keep these operating instructions handy for future reference.

- 1) Read these instructions.
- 2) Keep these instructions.
- 3) Heed all warnings.
- 4) Follow all instructions.
- 5) Do not use this apparatus near water.
- 6) Clean only with dry cloth.
- 7) Do not block any ventilation openings. Install in accordance with the manufacturer's instructions.
- 8) Do not install near any heat sources such as radiators, heat registers, stoves, or other apparatus (including amplifiers) that produce heat.
- 9) Do not defeat the safety purpose of the polarized or grounding-type plug. A polarized plug has two blades with one wider than the other. A grounding-type plug has two blades and a third grounding prong. The wide blade or the third prong are provided for your safety. If the provided plug does not fit into your outlet, consult an electrician for replacement of the obsolete outlet.
- 10) Protect the power cord from being walked on or pinched particularly at plugs, convenience receptacles, and the point where they exit from the apparatus.
- 11) Only use attachments/accessories specified by the manufacturer.
- 12) Use only with the cart, stand, tripod, bracket, or table specified by the manufacturer, or sold with the apparatus. When a cart is used, use caution when moving the cart/apparatus combination to avoid injury from tip-over.
- 13) Unplug this apparatus during lightning storms or when unused for long periods of time.
- 14) Refer all servicing to qualified service personnel. Servicing is required when the apparatus has been damaged in any way, such as power-supply cord or plug is damaged, liquid has been spilled or objects have fallen into the apparatus, the apparatus has been exposed to rain or moisture, does not operate normally, or has been dropped.



## Getting started

<b>IMPORTANT SAFETY INSTRUCTIONS</b> . . . . .	2
<b>Useful features</b> . . . . .	3
<b>Accessories</b> . . . . .	4
<b>The remote control</b> . . . . .	4
<b>Control reference guide</b> . . . . .	5
<b>STEP 1 Connection</b> . . . . .	6
<b>STEP 2 Setting up the TV Guide On Screen™ system</b> . . . . .	10
<b>STEP 3 Set up to match your television and remote control</b> . . . . .	12
<b>HDD, disc and card information</b> . . . . .	14

## Recording

<b>Recording television programs</b> . . . . .	16
Recording modes and approximate recording times . . . . .	17
Selecting audio to record . . . . .	17
Playing while you are recording . . . . .	18
Flexible Recording . . . . .	18
<b>Timer recording</b> . . . . .	19
Using the TV Guide On Screen™ system to make timer recordings . . . . .	19
Manually programming timer recordings . . . . .	20
Using VCR Plus+ system to make timer recordings . . . . .	20
Check, change or delete a program . . . . .	21
<b>Utilizing the TV Guide On Screen™ system</b> . . . . .	22

## Playing back

<b>Playing recorded video contents</b>	
<b>/Playing play-only discs</b> . . . . .	24
Operations during play . . . . .	25
Editing operations during play . . . . .	26
Changing audio during play . . . . .	26
<b>Using menus to play MP3</b> . . . . .	27
<b>Playing still pictures</b> . . . . .	28
Useful functions during still picture play . . . . .	29
<b>Using on-screen menus and Status messages</b> . . . . .	30
On-screen menus . . . . .	30
Status messages . . . . .	31

## Editing

<b>Editing titles/chapters</b> . . . . .	32
Editing titles/chapters and playing chapters . . . . .	32
Title operations . . . . .	33
Chapter operations . . . . .	33
<b>Creating, editing and playing play lists</b> . . . . .	34
Creating play lists . . . . .	34
Editing and playing play lists/chapters . . . . .	35
Play list operations . . . . .	35
Chapter operations . . . . .	35
<b>Editing still pictures</b> . . . . .	36
Picture and folder operation . . . . .	36

## Useful features

This DVD Video recorder records high quality images to rapid random access capable HDD (Hard disk drive) or DVD-RAM. This has resulted in many new features that outperform older tape formats. The following information summarizes a few of these features.

### Instant recording

You no longer need to search for empty disc space. By pressing the recording button, the unit finds available recording space and begins recording right away. There is no need to worry about overwriting already recorded content.

### HDD recording

You can keep on recording your favorite programs to an internal HDD that is able to record up to 284 hours when using EP (8H) mode. You can also high speed transfer (dub) your favorite programs to DVD-RAM or DVD-R and create a backup disc.

### SD/PC card slots, DV input terminal

This unit is equipped with interfaces that allow networking with digital equipment.

- The SD/PC card slots of this unit let you transfer (dub) digital camera photographs from a card to DVD-RAM for easy storage without using a computer.
- The DV automatic recording function of this unit lets you easily transfer (dub) digital images to the HDD by connecting only a single DV cable.

## Transfer (Dubbing)

<b>Transferring (dubbing) titles or play lists</b> . . . . .	37
One Touch Transfer (dubbing) . . . . .	38
Transferring (dubbing) using the transferring (dubbing) list . . . . .	38
Transferring (dubbing) a finalized DVD-R . . . . .	40
<b>Recording from a video cassette recorder</b> . . . . .	41
Manual recording . . . . .	41
DV automatic recording (DV AUTO REC) . . . . .	41
<b>Transferring (dubbing) still pictures</b> . . . . .	42
Transferring (dubbing) using the transferring (dubbing) list . . . . .	42
Transferring (dubbing) all the still pictures on a card —COPY ALL PICTURES . . . . .	43

## Convenient functions

<b>FUNCTIONS window</b> . . . . .	43
<b>HDD, disc and card setting</b> . . . . .	44
Setting the protection . . . . .	44
Providing a disc with a name . . . . .	44
Erasing all titles and play lists—Erase all titles . . . . .	44
Erasing all the contents of a disc or card—Format . . . . .	45
Enabling DVD-R to be played on other equipment—Finalize . . . . .	45
<b>Entering text</b> . . . . .	46
<b>Changing the unit's settings</b> . . . . .	47
Common procedures . . . . .	47
Summary of settings . . . . .	47
<b>Channel/Clock settings when TV Guide On Screen™ system is not used</b> . . . . .	50
Auto channel/clock settings . . . . .	50
Channel captions . . . . .	51

## Reference

<b>Specifications</b> . . . . .	52
<b>Glossary</b> . . . . .	53
<b>Frequently asked questions</b> . . . . .	54
<b>Error messages</b> . . . . .	56
<b>Troubleshooting guide</b> . . . . .	57
<b>Product Service</b> . . . . .	61
<b>Maintenance/HDD, disc and card handling</b> . . . . .	62
<b>Limited Warranty</b> . . . . .	63
<b>Index</b> . . . . .	Backcover

### TV Guide On Screen™ system

The TV Guide On Screen™ system provides a handy electronic program guide (EPG) for checking what's on. Setting up to record a broadcast is easy too. Simply select the desired program from the displayed list. You can also search for desired programs alphabetically or by displaying only the programs in a certain category.

- This service may not be available in some areas.

### Instant play

There is no need to rewind or search forward. Direct Navigator guides you to the beginning of the recorded video immediately.



### Chasing playback

There is no need to wait until recording is complete. Without stopping recording, you can play the video currently being recorded from its beginning.



### Simultaneous Recording and Playback

While recording, you can play another video program that was recorded previously.



### Time Slip

During play and also while recording, you can jump to the scene you wish to view by specifying the skip time.

# Accessories



Please check and identify the supplied accessories. Use numbers indicated in parentheses when asking for replacement parts. **To order accessories, contact 1-800-833-9626.**



**1 Remote control**  
(EUR7721KL0)

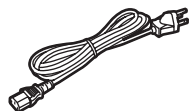

**1 AC power supply cord**  
(K2CG3CH00001)

•For use with this unit only. Do not use it with other equipment.



**1 75 Ω coaxial cable**  
(VJA1125)



**2 Batteries**  
for remote control



**1 Audio/video cable**  
(K2KA6CA00001)



**1 IR Blaster**  
(K2ZZ04C00002)



**1 BNC-RCA adaptor plug set**  
(K2RB063E00002)

## The remote control

### ■ Batteries

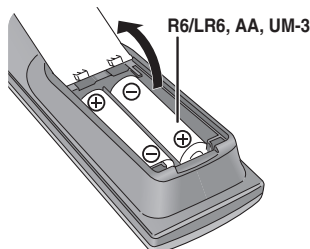

- Insert so the poles (+ and -) match those in the remote control.
- Do not use rechargeable type batteries.
- Do not mix old and new batteries.
- Do not use different types at the same time.
- Do not heat or expose to flame.
- Do not take apart or short circuit.
- Do not attempt to recharge alkaline or manganese batteries.
- Do not use batteries if the covering has been peeled off.

Mishandling of batteries can cause electrolyte leakage which can damage items the fluid contacts and may cause a fire.

Remove if the remote control is not going to be used for a long period of time. Store in a cool, dark place.

### Note

If you cannot operate the unit or television using the remote control after changing the batteries, please re-enter the codes (→ page 12, 13).

### ■ Use

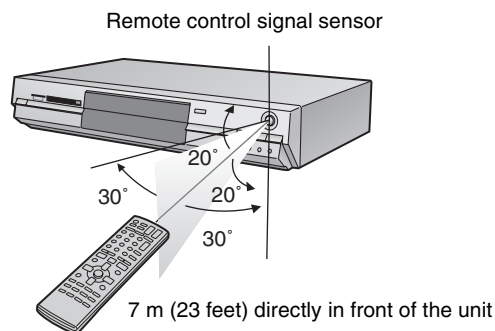

**The manufacturer accepts no responsibility and offers no compensation for loss of recorded or edited material due to a problem with the unit or recordable media, and accepts no responsibility and offers no compensation for any subsequent damage caused by such loss.**

#### Examples of causes of such losses are

- A disc recorded and edited with this unit is played in a DVD recorder or computer disc drive manufactured by another company.
- A disc used as described above and then played again in this unit.
- A disc recorded and edited with a DVD recorder or computer disc drive manufactured by another company is played in this unit.

## Remote control

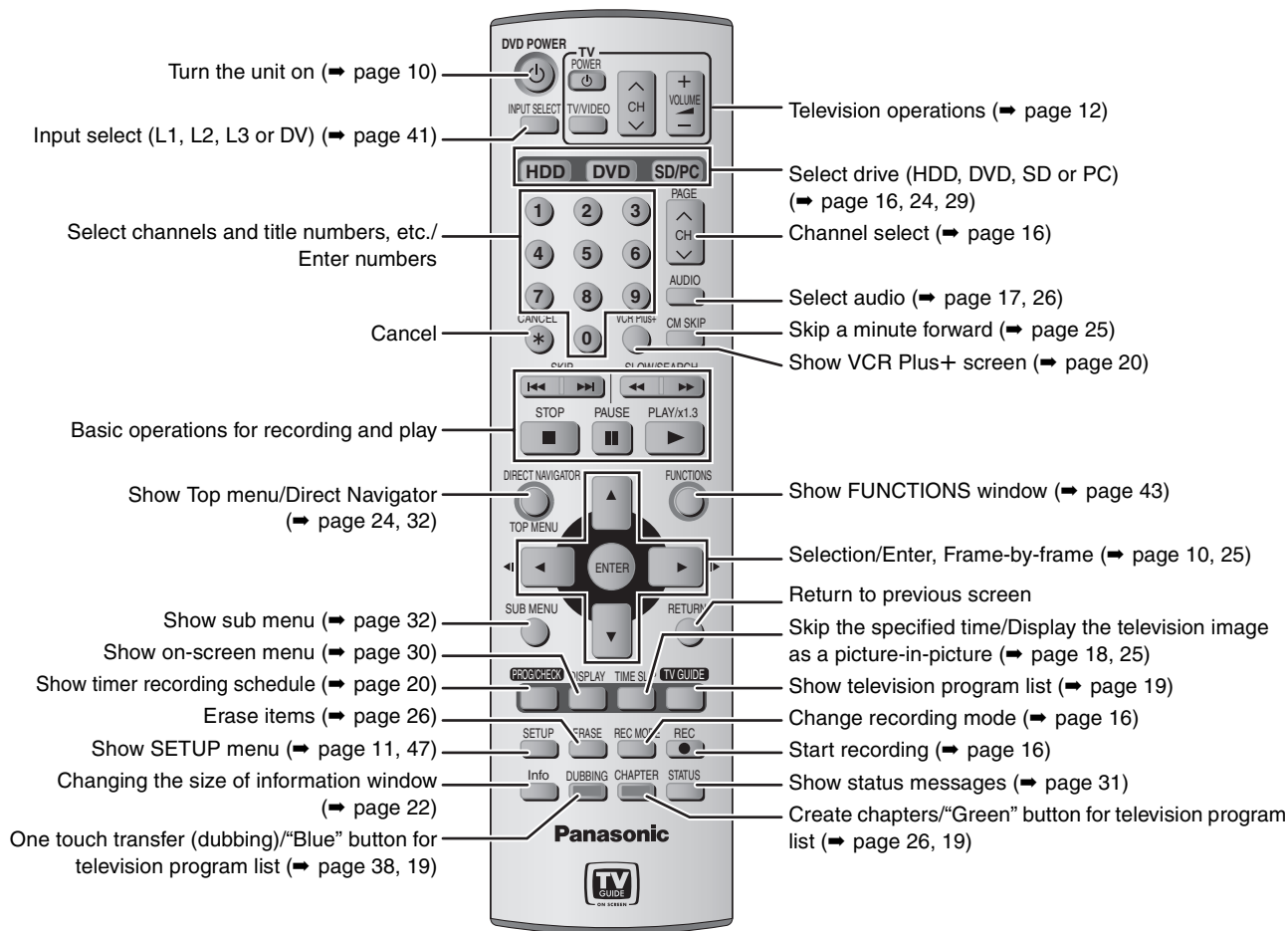

## Main unit

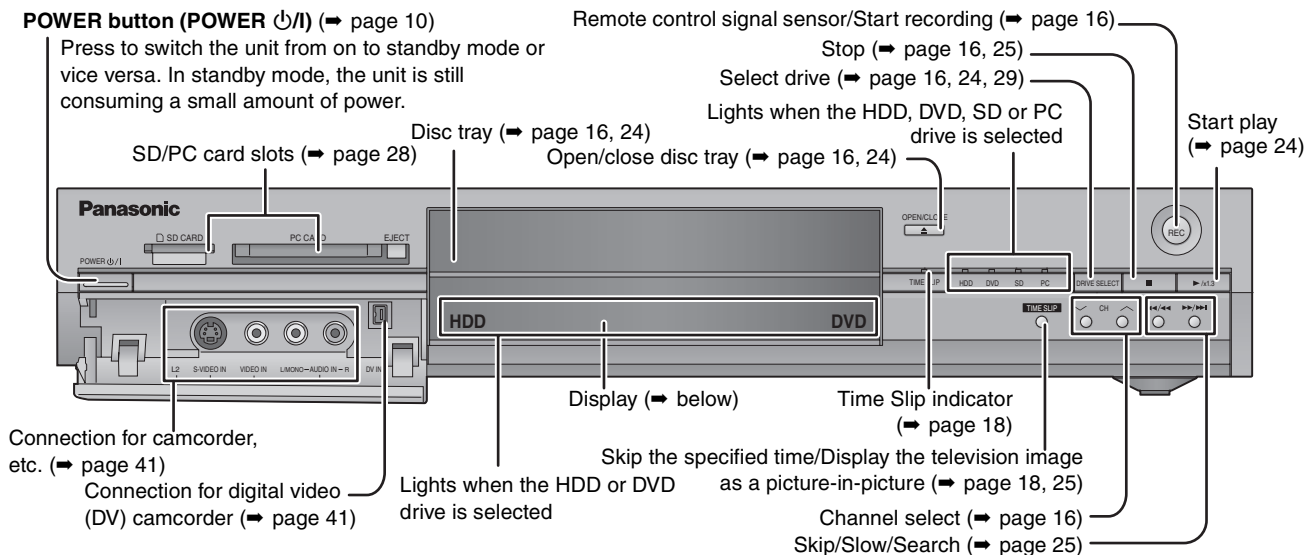

Rear panel terminals (⇒ page 7)

## The unit's display

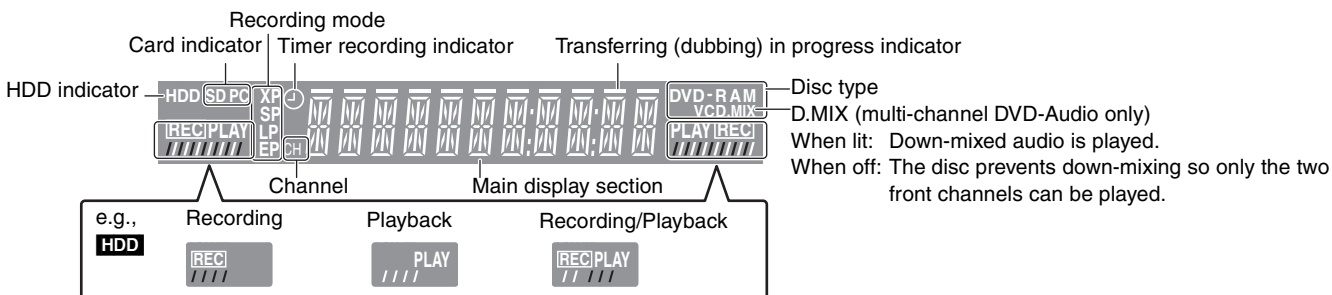

# STEP 1 Connection

## ■ Examples of equipment you can connect to this unit's terminals

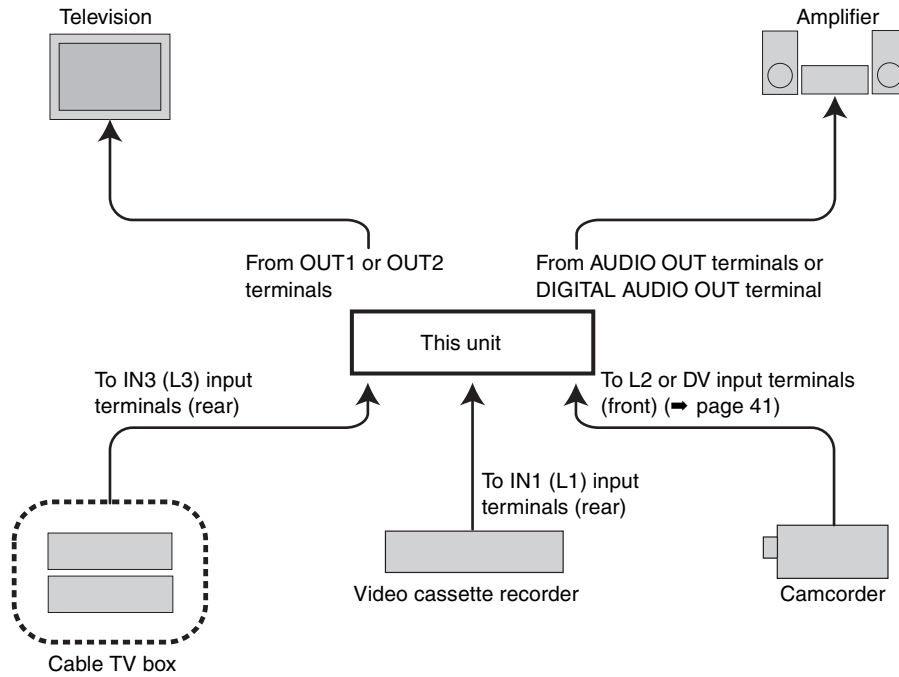

### Do not place the unit on amplifiers or equipment that may become hot.

The heat can damage the unit.



### ■ When the unit is not to be used for a long time

To save power, unplug it from the household AC outlet. This unit consumes a small amount of power, even when it is turned off (**approx. 15 W**).

- Note that the television program list is not downloaded while the unit is unplugged.

**Before moving the unit, ensure the disc tray is empty.**  
Failure to do so will risk severely damaging the disc and the unit.

- The equipment connections described are examples.
- Before connection, turn off all equipment and read the appropriate operating instructions.
- Peripheral equipment and optional cables sold separately unless otherwise indicated.

## Connection with a television and video cassette recorder

The connection will allow the video cassette recorder to be used for playback when this unit is turned off. Change the video input appropriately on the television. For optimum operation, it is recommended that this unit be connected as shown below.

- indicates included accessories.
- indicates accessories not included.

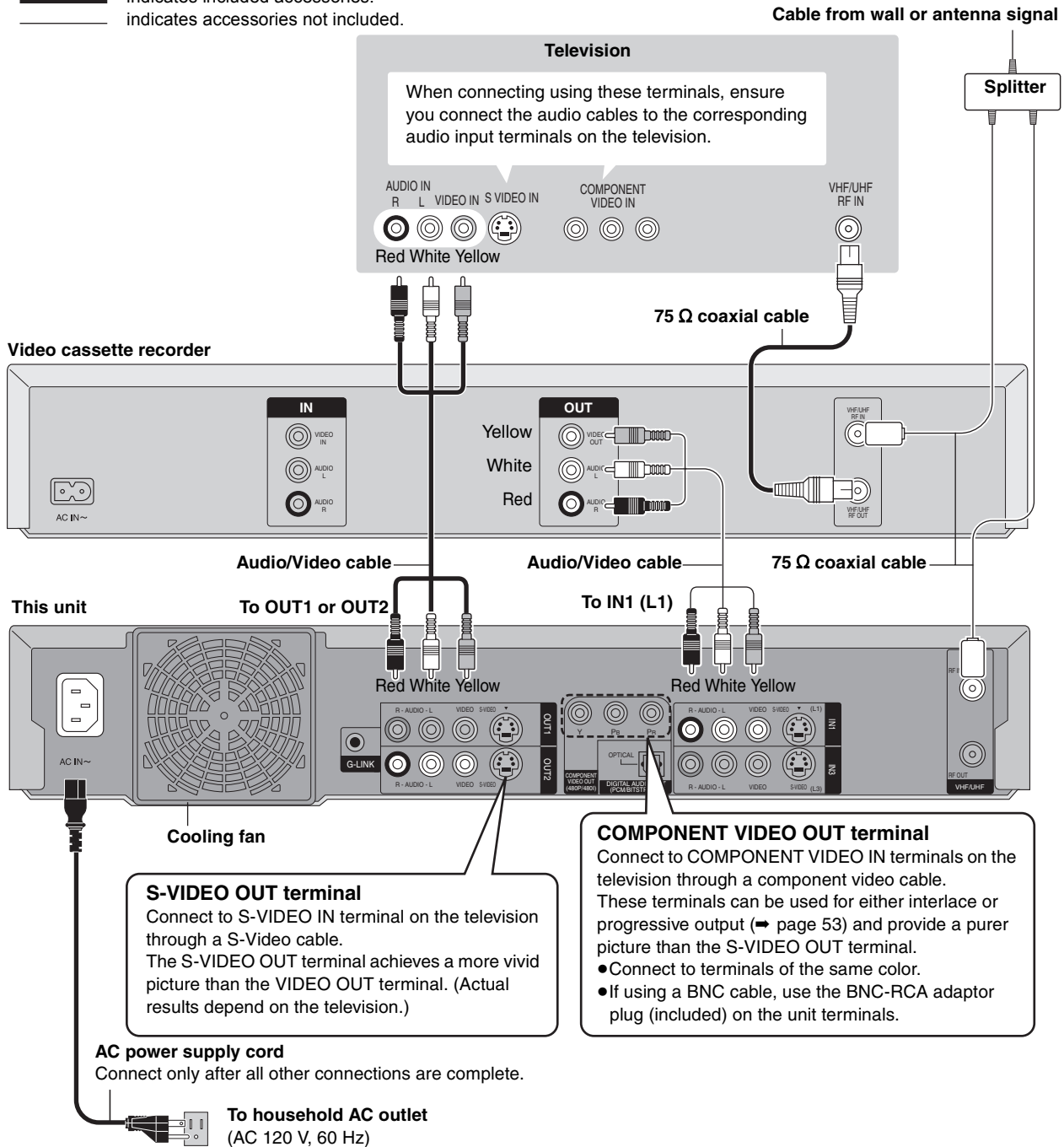

### ■ The unit's RF OUT terminal

The picture and sound signal from this unit does not go through the RF OUT terminal to the television.

Make sure you connect one of the following terminals on this unit to the television: the AUDIO/VIDEO OUT terminal, the S-VIDEO OUT terminal or the COMPOONENT VIDEO OUT terminal. If the television has none of these terminals, consult your local dealer.

- Refer to page 9 if the antenna connector doesn't match.

### Do not connect the unit through a video cassette recorder

Video signals fed through video cassette recorders will be affected by copyright protection systems and the picture will not be shown correctly on the television.

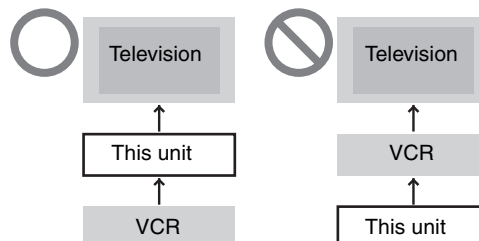

- When connecting to a television with a built in VCR, connect to the input terminals on the television side, not the VCR side.

# STEP 1 Connection

## Connection with a cable TV box and video cassette recorder

- You need to subscribe to a cable TV service to enjoy viewing their programming.
- Consult your service provider regarding appropriate cable TV box.
- If you receive your programming solely from a satellite service, the program guide in this unit will not receive program listings or channel information. Without this information, program-based recordings cannot be made. However, recordings can still be set manually.

The connection will allow the video cassette recorder to be used for playback when this unit is turned off. Change the video input appropriately on the television. For optimum operation, it is recommended that this unit be connected as shown below.

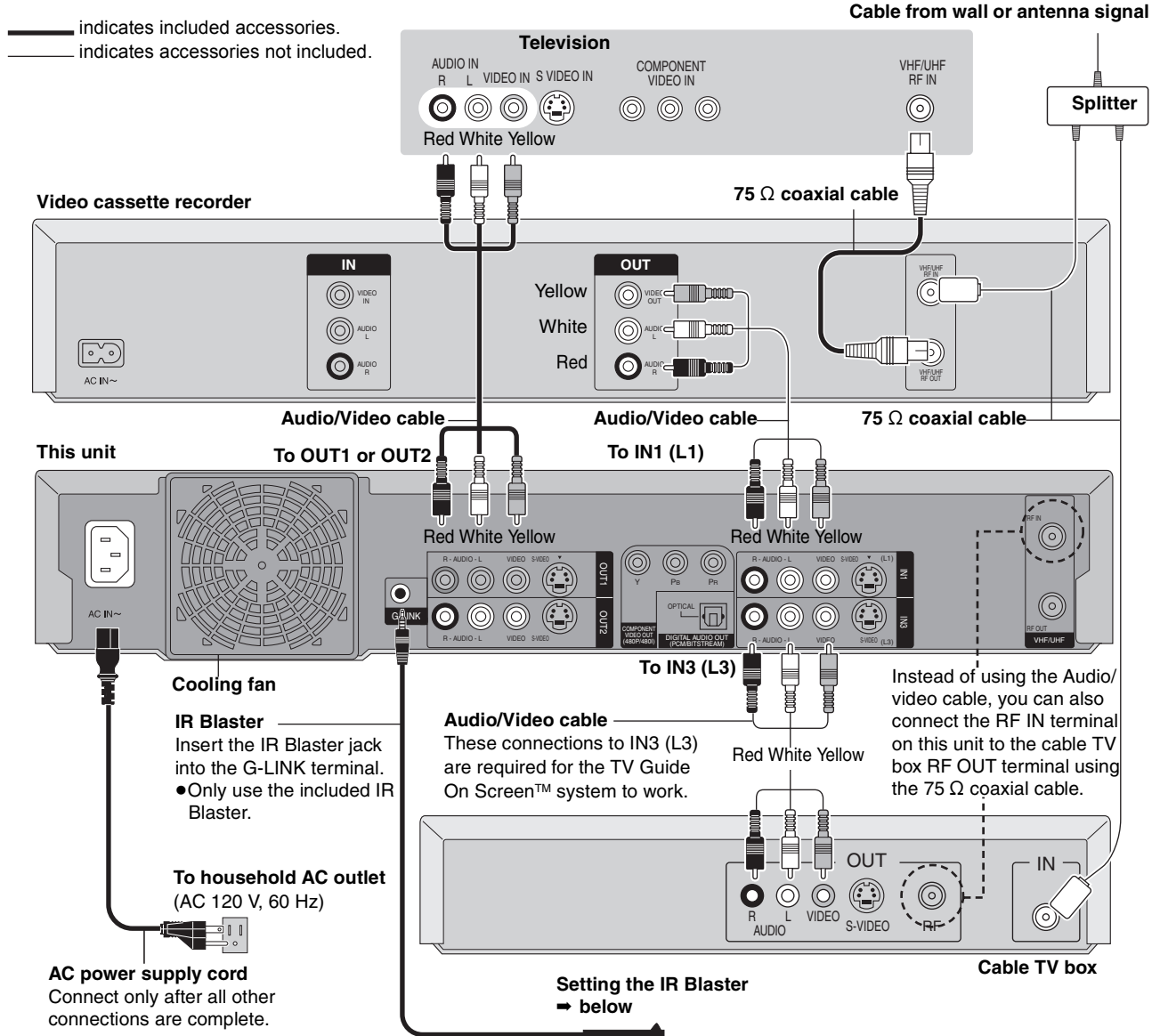

### ■ Should I use the AUDIO/VIDEO OUT terminal or the RF OUT terminal?

If your cable TV box has both AUDIO/VIDEO OUT terminals and RF OUT terminals, we recommend connecting the AUDIO/VIDEO OUT terminal with the unit's IN3 (L3) terminal. Using this connection provides better picture quality.

- The S-VIDEO terminal achieves a more vivid picture than the VIDEO terminal.

### ■ Why should I connect the IR Blaster?

The IR Blaster is a device that allows this unit to communicate with the cable TV box. It acts like a remote control for the cable TV box. If you connect a cable TV box to this unit, you also need to attach the IR Blaster so this unit can control the channels on the cable TV box.

### Setting the IR Blaster

Place the IR Blaster in front of the signal sensor of the cable TV box.

Read the cable TV box operating instructions regarding positioning of the signal sensor.

If necessary, use the double sided adhesive tape (included) to secure the IR Blaster to a flat surface.

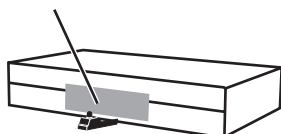

e.g. Television stand surface

If you peel off the adhesive tape, the surface may become damaged.

Once you have confirmed the cable TV box is operating correctly, secure it by attaching the adhesive tape.

Cable TV box



## Connecting an amplifier or system component

### ■ Connection to a stereo amplifier

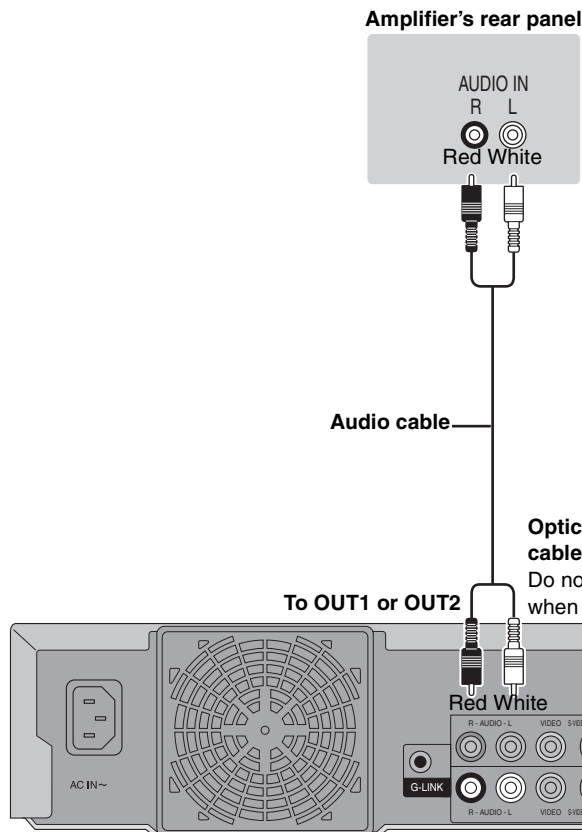

### ■ To enjoy multi-channel surround sound on DVD-Video

Connect an amplifier with a built-in decoder displaying these logo marks. Use an optical digital audio cable and change the settings in "Digital Audio Output" (→ page 49).



- You cannot use DTS Digital Surround decoders not suited to DVD.
- Even if using this connection, output will only be from 2 channels when playing DVD-Audio.

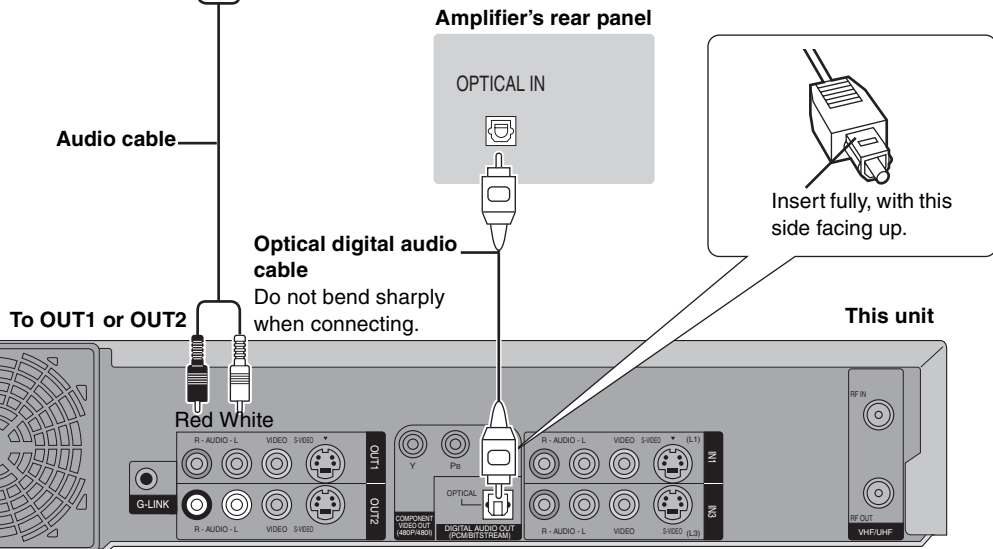

## If the antenna connector doesn't match

### Other antenna connections to the unit

Use one of the following connections to suit the antenna lead.

- If your television has both lead and coaxial VHF terminals, use the lead connection to minimize signal loss.

#### ■ A single twin lead

from the antenna

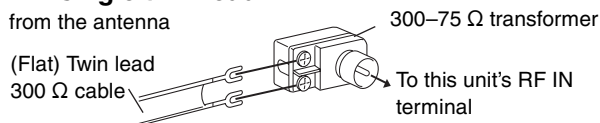

#### ■ A twin lead and a coaxial cable

from the antenna

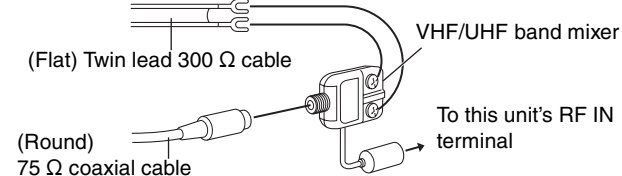

#### ■ Two twin leads

from the antenna

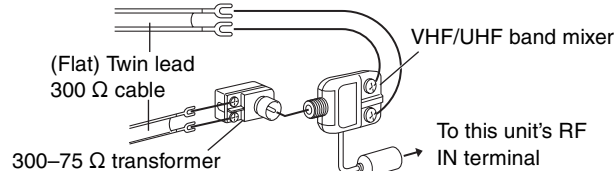

### Other antenna connections from the unit to the television

Use one of the following connections to suit the antenna terminals on your television. Refer to the television's operating instructions.

#### ■ A twin lead and coaxial plug terminal

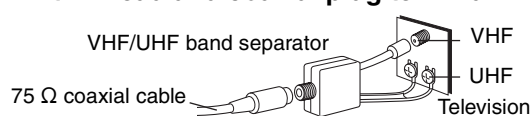

#### ■ A twin lead terminal



#### ■ Two twin lead terminals



#### ■ Multiple antenna terminals

- Connect to one of the ANT terminals, then change the television's settings as necessary.

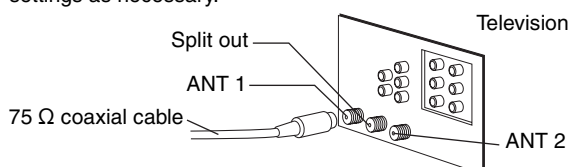

## STEP 2 Setting up the TV Guide On Screen™ system

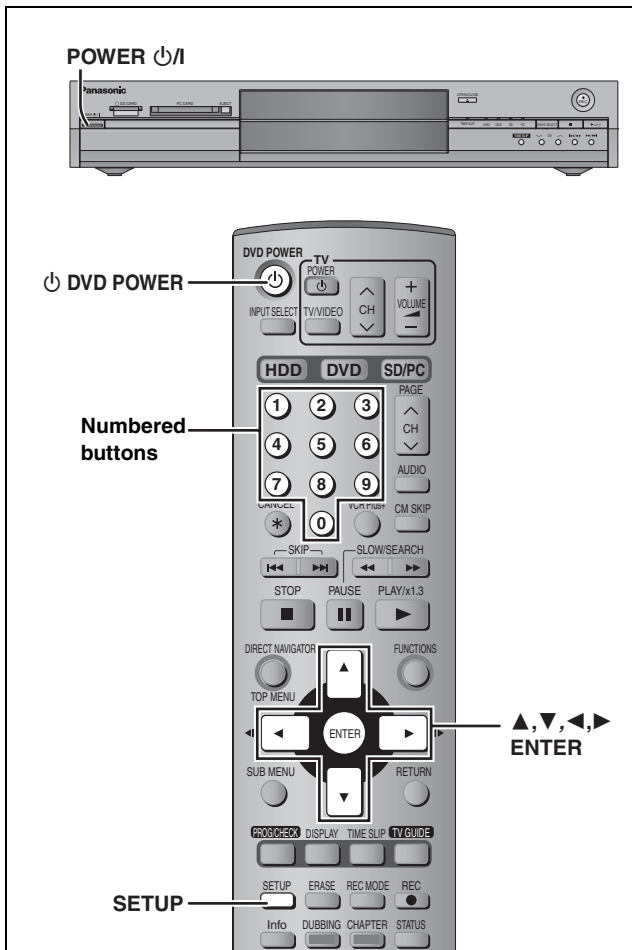

After plugging the unit into your household AC outlet and pressing [DVD POWER] to turn the unit on for the first time, the unit starts TV Guide On Screen™ system setup.

**IMPORTANT: The TV Guide On Screen™ system must be setup whether it is then used or not. You cannot use the timer recording feature unless this setup is completed.**

**Only English is displayed in the TV Guide On Screen™ system. Other languages cannot be displayed.**

### TV Guide On Screen™ system

This unit features the TV Guide On Screen™ system that provides an 8-day rolling list of TV programs available in your area. Use the TV Guide On Screen™ system to choose TV programs and simplify the recording of your favorite TV shows (➔ page 19–23). Best of all this service is free!

- If you receive your programming solely from a satellite service, the program guide in this unit will not receive program listings or channel information. Without this information, program-based recordings cannot be made. However, recordings can still be set manually.
- In order to cool the circuits used when downloading the television program list, the cooling fan may sometimes operate when the unit is turned off. This is not a malfunction.

### Preparation

- Turn on the television and select the appropriate video input to suit the connections to this unit.
- When using the cable TV box, check the following.
  - Make sure the IR Blaster is connected and positioned properly (➔ page 8).
  - Make sure the cable TV box is turned on.

## 1 Press [DVD POWER].



## 2 Following the on-screen messages, input the operating environment for your television.

- Move the cursor using [▲, ▼, ◀, ▶] and press [ENTER] to confirm.
- Press the numbered buttons to enter numbers.
- Press [ENTER] to advance to the next screen.
- Refer to the guidance on the bottom of the screen.

### Set the following;

- Country (USA/Canada)

Which country is your DVD Recorder located in?

**USA**

Canada

- ZIP (Postal) code

Please enter the 5-digit ZIP code where your DVD Recorder is located:

**= = = = =**

- Cable service connected to this unit (Yes/No)

Do you have cable service connected to this DVD Recorder?

**Yes**

No

When “No” is selected ➔ right, “The set contents are displayed together”

- Cable TV box connected to this unit (Yes/No)

Is a cable box connected to this DVD Recorder?

**Yes**

No

When “No” is selected ➔ right, “The set contents are displayed together”

**If you do not want to use the TV Guide On Screen™ system** Select “No” at this point even if a cable TV box is connected.

### If you are using a cable TV box, set the following:

- Cable TV box connection channel (Ch2/Ch3/Ch4/L3)
  - If you are connecting the cable TV box to this unit’s IN3 (L3) terminal, select “L3”.
  - If you are connecting the cable TV box to this unit’s RF terminal, select “Ch2”, “Ch3” or “Ch4”, according to the cable TV box setting.
- Cable TV box brand (Move down with [▼] for more brands. Select “Not Listed” if you cannot find your cable TV box on the list.)
- IR signal code  
Make sure your cable TV box is set to the channel that appears on screen and press [ENTER].

Follow steps A and B below:

- A. Please tune your cable box **channel 02**
- B. Make sure to leave your cable box **turned ON**

The unit begins trying various IR codes to see which one communicates properly with your cable TV box. It's quite common for this phase of the setup to be repeated numerous times.



–If the cable TV box has changed to channel 09, select “Yes” and press [ENTER].

–If the cable TV box is still set to the same channel, select “No” and press [ENTER]. Repeat this step until the cable TV box changes to channel 09.

### ■ The set contents are displayed together

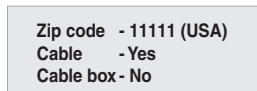

–If the information is correct, select “Yes, end setup” and press [ENTER].

–If the information is not correct, select “No, repeat setup process” and press [ENTER] to start the setting again.

Once you confirm the input content, the following screen appears.

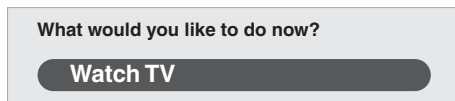

### 3 Press [ENTER].

A television reception screen or a blue background screen is displayed.

**If you do not want to use TV Guide On Screen™ system**  
➔ page 50, Auto channel/clock settings

### 4 Press [⏻ DVD POWER].

“BYE” appears briefly and then “12:00A” flashes on the unit’s display. The unit is now in standby mode and ready to download the channel line-up and the program listings.

Check the following again, so the downloading will not fail.

#### **If you connect a cable TV box**

- the output terminal of the cable TV box is connected to this unit’s RF IN or IN3 (L3) terminal (➔ page 8)
- the IR Blaster is correctly connected and installed (➔ page 8)
- the cable TV box is turned on

#### **If you do not connect a cable TV box**

- the antenna cable is connected to this unit’s RF IN terminal

### 5 Leave this unit in the standby mode.

It is strongly recommended that you wait at least 24 hours before using the unit. No damage will occur if the unit is used sooner, but the channel line-up and program listings may not have been fully downloaded.

- If you connect a cable TV box, leave it switched on without using it.
- With some cable TV boxes, the cable TV box remote control can turn on and off both the cable TV box and the television. Utilizing this feature (turning the cable TV box off) will prevent the channel line-up from being downloaded.

If you find “There is no data for this screen” displayed on the television when you turn the unit on, the unit has not yet downloaded the channel line-up.

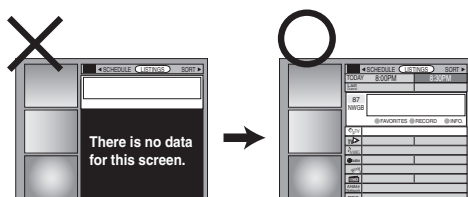

This unit may download more than one channel line-up. Follow the on-screen guidance and select one of these.

### To use immediately (Manual Clock Setting)

Set the clock manually.

Please note that the program list is not displayed until the unit downloads it. Timer program recording is only possible manually.

- 1 Press [SETUP].
- 2 Press [▲, ▼] to select “Set Up” and press [▶].
- 3 Press [▲, ▼] to select “Manual Clock Setting” and press [ENTER].

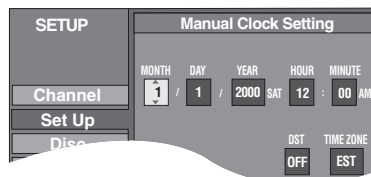

- 4 Press [◀, ▶] to select the item you want to change and press [▲, ▼] to change the setting.
- 5 Press [ENTER].  
The clock starts.
- 6 Press [SETUP].

- DST (Daylight Saving Time): ON or OFF

If you select “ON”, the clock is advanced one hour starting at 2 a.m. on the first Sunday in April and ending at 2 a.m. on the last Sunday in October.

- TIME ZONE shows the time difference from Greenwich meantime (GMT).

EST (Eastern Standard Time)	= GMT – 5
CST (Central Standard Time)	= GMT – 6
MST (Mountain Standard Time)	= GMT – 7
PST (Pacific Standard Time)	= GMT – 8
AST (Alaska Standard Time)	= GMT – 9
HST (Hawaii Standard Time)	= GMT – 10

In the United States, TV GUIDE and other related marks are registered marks of Gemstar-TV Guide International, Inc. and/or one of its affiliates. In Canada, TV GUIDE is a registered mark of Transcontinental Inc., and is used under license by Gemstar-TV Guide International, Inc. TV Guide On Screen, G-LINK, VCR Plus+ and PlusCode are registered marks of Gemstar-TV Guide International and/or one of its affiliates.

The TV Guide On Screen and VCR Plus+ systems are manufactured under license from Gemstar-TV Guide International, Inc. and/or one of its affiliates.

**GEMSTAR-TV GUIDE INTERNATIONAL, INC. AND/OR ITS RELATED AFFILIATES ARE NOT IN ANY WAY LIABLE FOR THE ACCURACY OF THE PROGRAM SCHEDULE INFORMATION PROVIDED BY THE TV GUIDE ON SCREEN SYSTEM. IN NO EVENT SHALL GEMSTAR-TV GUIDE INTERNATIONAL, INC. AND/OR ITS RELATED AFFILIATES BE LIABLE FOR ANY AMOUNTS REPRESENTING LOSS OF PROFITS, LOSS OF BUSINESS, OR INDIRECT, SPECIAL, OR CONSEQUENTIAL DAMAGES IN CONNECTION WITH THE PROVISION OR USE OF ANY INFORMATION, EQUIPMENT, OR SERVICES RELATING TO THE TV GUIDE ON SCREEN SYSTEM.**

The TV Guide On Screen and VCR Plus+ systems are protected by one or more issued United States patents such as 6,331,877; 6,239,794; 6,154,203; 5,940,073; 4,908,713; 4,751,578; 4,706,121; 6,466,734; 6,430,359; 6,091,882; 6,049,652; 5,335,079; 5,307,173.

## STEP 3 Set up to match your television and remote control

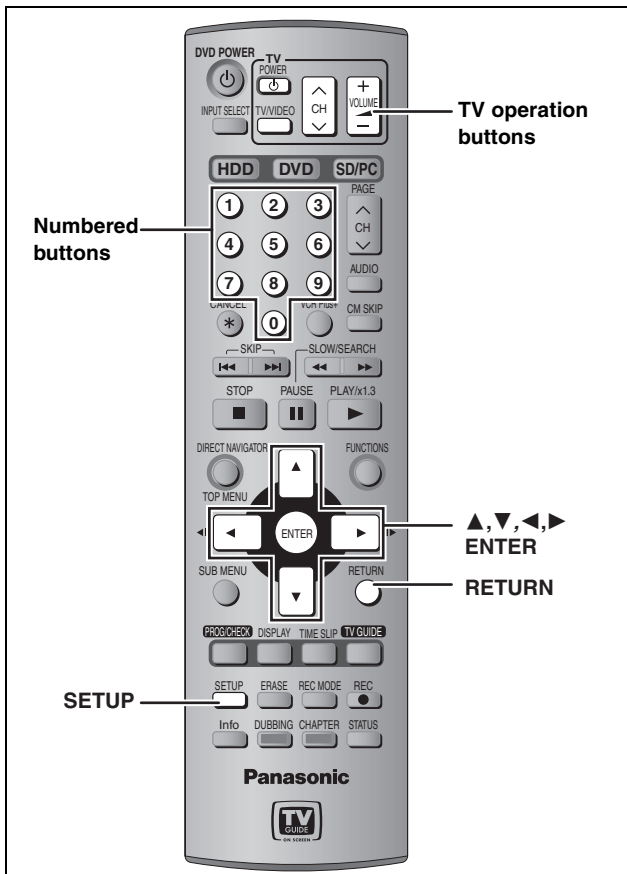

### Television operation

You can configure the remote control TV operation buttons to turn the television on/off, change the television input mode, select the television channel and change the television volume.

Point the remote control at the television

**While pressing [POWER TV], enter the code with the numbered buttons.**

e.g., 01: [0] → [1]

**Manufacturer and Code No.**

Panasonic		PHILIPS (RC-5)	03
National	01, 02	RCA	05
QUASAR		SAMSUNG	14, 18, 19
FISHER	10	SANYO	10
GE	05	SHARP	06, 07
GOLDSTAR	15, 16, 17	SONY	08
HITACHI	12	SYLVANIA	03
JVC	11	THOMSON	05
LG	15, 16, 17	TOSHIBA	09
MAGNAVOX	03	ZENITH	04
MITSUBISHI	13		

Test by turning on the television and changing channels. Repeat the procedure until you find the code that allows correct operation.

• If your television brand is not listed or if the code listed for your television does not allow control of your television, this remote control is not compatible with your television.

### Selecting television type

You do not have to change the setting when connected to a 4:3 standard aspect television that is not compatible with progressive output (→ page 53).

- 1 Press [SETUP].
- 2 Press [▲, ▼] to select “TV Screen” and press [▶].
- 3 Press [▲, ▼] to select “TV Type” and press [ENTER].

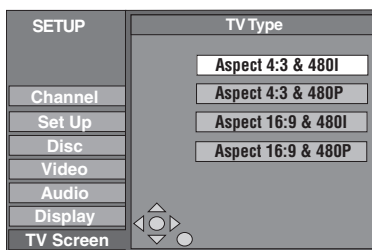

• Aspect 4:3/Aspect 16:9:



4:3 standard aspect television

16:9 widescreen television

• 480P/480i:

Select “480P” if the television is compatible with progressive output.

- 4 Press [▲, ▼] to select the item and press [ENTER].

**To exit the screen**

Press [SETUP].

**To return to the previous screen**

Press [RETURN].

## When other Panasonic products respond to this remote control

Change the remote control code on the main unit and the remote control (the two must match) if you place other Panasonic products close together.

Use "1", the factory set code, under normal circumstances.

- 1 Press [SETUP].
- 2 Press [▲, ▼] to select "Set Up" and press [▶].
- 3 Press [▲, ▼] to select "Remote Control Code" and press [ENTER].
- 4 Press [▲, ▼] to select the code (1, 2, or 3) and press [ENTER].

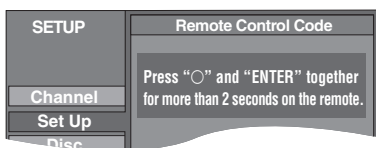

- 5 To change the code on the remote control  
While pressing [ENTER], press and hold the numbered button ([1], [2] or [3]) for more than 2 seconds.
- 6 Press [ENTER].

- When the following indicator appears on the unit's display



Change the code on the remote control to match the main unit's (→ step 5).

---



### To exit the screen

Press [SETUP].

### To return to the previous screen

Press [RETURN].

## HDD and discs you can use for recording and play

Type	Logo	Instructions
<b>Hard disk drive (HDD)</b> ● 160 GB Indicated in these instructions with <b>HDD</b>	-	<b>Temporary storage</b> <ul style="list-style-type: none"> <li>You can record up to 284 hours [in EP (8H) mode] (⇒ page 17, Recording modes and approximate recording times).</li> <li>You can view the title being recorded from the beginning (Chasing playback, Time Slip) (⇒ page 18).</li> <li>You can record digital broadcasts that allow "One time only recording". You can transfer (dub) a recorded title to a CPRM compatible DVD-RAM; however, the title is erased from the HDD (⇒ page 53).</li> <li>You can play and transfer (dub) still pictures taken on a digital camera etc. (⇒ page 28, 42).</li> </ul>
<b>DVD-RAM</b> ● 4.7 GB/9.4 GB, 12 cm (5") ● 2.8 GB, 8 cm (3") <b>RAM</b>		<b>Re-writable discs for backup use</b> <ul style="list-style-type: none"> <li>You can record approximately up to 8 hours on a single-sided disc and 16 hours on a double-sided disc (⇒ page 17, Recording modes and approximate recording times).</li> <li>You can view the title being recorded from the beginning (Chasing playback, Time Slip) (⇒ page 18).</li> <li>Scratch and dust resistant cartridge discs and large capacity double sided discs (9.4GB) are commercially available.</li> <li>You can record digital broadcasts that allow "One time only recording" when using CPRM (Content Protection for Recordable Media) compatible discs (⇒ page 53). You cannot transfer (dub) a recorded title.</li> <li>This unit is compatible with 1×–3× recording speed discs.</li> <li>You can transfer (dub) up to 24× recording speed by using a high speed recording compatible disc (⇒ page 37).</li> <li>You can play and transfer (dub) still pictures taken on a digital camera etc. (⇒ page 28, 42).</li> </ul>
<b>DVD-R</b> ● 4.7 GB, 12 cm (5") ● 1.4 GB, 8 cm (3") <b>DVD-R</b>		<b>One time recording discs for backup use (recordable until the disc is full)</b> <ul style="list-style-type: none"> <li>You can record up to 8 hours [in EP (8H) mode] (⇒ page 17, Recording modes and approximate recording times).</li> <li>By finalizing the disc, you can play it in a DVD player as DVD-Video (Play only) (⇒ page 45, 53).</li> <li>You cannot record digital broadcasts that allow "One time only recording".</li> <li>This unit is compatible with 1×–4× recording speed discs.</li> <li>You can transfer (dub) up to 32× recording speed by using a high speed recording compatible disc (⇒ page 37).</li> </ul>

● We recommend using Panasonic discs and cards. DVD-R from other manufacturers may not be recorded or played due to the condition of the recording.

### ■ Which should I use, DVD-RAM or DVD-R?

The following chart indicates the differences. Select based upon what you require.





(○:Possible, X:Impossible)	DVD-RAM	DVD-R
Re-writable	○	X
Edit	○	※1
Play on other players	○※2	○※3
Recording both Main and SAP of MTS broadcast	○	X※4
Recording broadcasts that allow one copy	○※5	X
Recording 16:9 aspect picture	○	※6

- ※1 You can erase, enter name and change thumbnail. Available space does not increase after erasing.
- ※2 Only on DVD-RAM compatible players.
- ※3 After finalizing the disc (⇒ page 45, 53).
- ※4 Only one is recorded (⇒ page 48, Select MTS).
- ※5 CPRM (⇒ page 53) compatible discs only.
- ※6 The picture is recorded in 4:3 aspect.

#### Note

When "DVD-R High-Speed Recording" is set to "On" the restrictions on secondary audio recording, etc. are also applied to DVD-RAM. Turn this setting "Off" if high speed transfer (dubbing) to DVD-R is not necessary when recording a program (⇒ page 48).

## Play-only discs [12 cm (5")/8 cm (3")]

Disc type	Logo	Instructions
<b>DVD-Audio</b> <b>DVD-A</b>		High fidelity music discs <ul style="list-style-type: none"> <li>Played on this unit in 2 channels.</li> </ul>
<b>DVD-Video</b> <b>DVD-V</b>	 	High quality movie and music discs
<b>Video CD</b> <b>VCD</b>		Recorded music and video (including CD-R/RW)
<b>Audio CD</b> <b>CD</b>		Recorded audio and music (including CD-R/RW)
	-	CD-R and CD-RW with music recorded in MP3 (⇒ page 27)

● This unit plays CD-R/CD-RW discs (audio recording discs) which have been recorded under one of the following standards: CD-DA, MP3 and Video CD. Close the session or finalize the disc after recording.

Play may be impossible on some CD-R or CD-RW discs due to the condition of the recording.

● The producer of the disc can control how discs are played. So you may not always be able to control play as described in these operating instructions. Read the disc's instructions carefully.

## Discs that cannot be played

- 2.6 and 5.2 GB DVD-RAM, 12 cm (5")
- 3.95 and 4.7 GB DVD-R for Authoring
- Unfinalized DVD-R recorded on other equipment (⇒ page 53, Finalize)
- PAL discs (you can still play the audio on DVD-Audio)
- DVD-Video with a region number other than "1" or "ALL"
- DVD-ROM, DVD-RW, +R, +RW, CD-ROM, CDV, CD-G, Photo CD, CVD, SVCD, SACD, MV-Disc, PD, Divx Video Disc, etc.

## Cards useable on this unit

	Type	Instructions
<b>SD Memory Card<sup>*1</sup></b> <b>MultiMediaCard</b>	You can insert directly into the SD card slot. <b>SD</b>	<ul style="list-style-type: none"> <li>You can play and transfer (dub) still pictures taken on a digital camera etc. (⇒ page 28, 42).</li> <li>You can set the DPOF (Digital Print Order Format) for automatic printing on your home printer or at a photo developing store (⇒ page 36, 53).</li> </ul>
<b>SD Memory Card</b> <b>MultiMediaCard</b> <b>CompactFlash</b> <b>SmartMedia</b> <b>MEMORYSTICK</b> <b>xD-Picture Card</b> <b>Microdrive</b>	You can insert into the PC card slot using an adaptor (TYPE II PC card adaptor). <b>PC</b>	<ul style="list-style-type: none"> <li><b>Compatible with:</b> FAT 12 or FAT 16</li> <li>We recommend using a Panasonic SD card.</li> <li>You cannot use SD cards that exceed 2 GB.</li> <li>We recommend using this unit to format a card before recording (⇒ page 45, 53).</li> <li>You may not be able to use the card if formatted on a computer.</li> </ul>
<b>ATA Flash PC Card</b> <b>Mobile hard disk<sup>*2</sup></b>	You can insert directly into the PC card slot. <b>PC</b>	<p><sup>*1</sup> Includes miniSD™ Cards. A miniSD™ adaptor needs to be inserted before using these cards.</p> <p><sup>*2</sup> Content saved on SD media storage (SV-PT1). You can only play the saved still pictures and transfer (dub) the data onto other cards, HDD or DVD-RAM.</p>

### Structure of folders displayed by this unit

The following  can be displayed on this unit.

\*\*\*: Numbers      XXX: Letters

#### Card

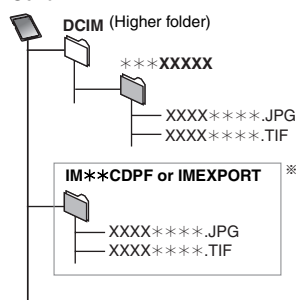

#### DVD-RAM

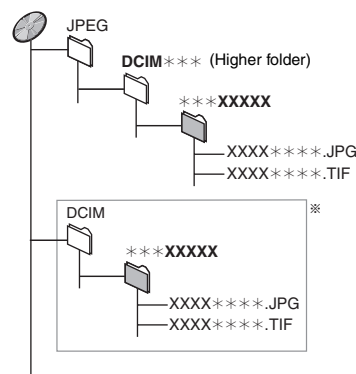

\* Folders can be created on other equipment. However, these folders cannot be selected as a transferring (dubbing) destination.

• The folder cannot be displayed if the numbers are all "0" (e.g., DCIM000 etc).

• If a folder name or filename has been input using other equipment, the name may not be displayed properly or you may not be able to play or edit the data.

# Recording television programs

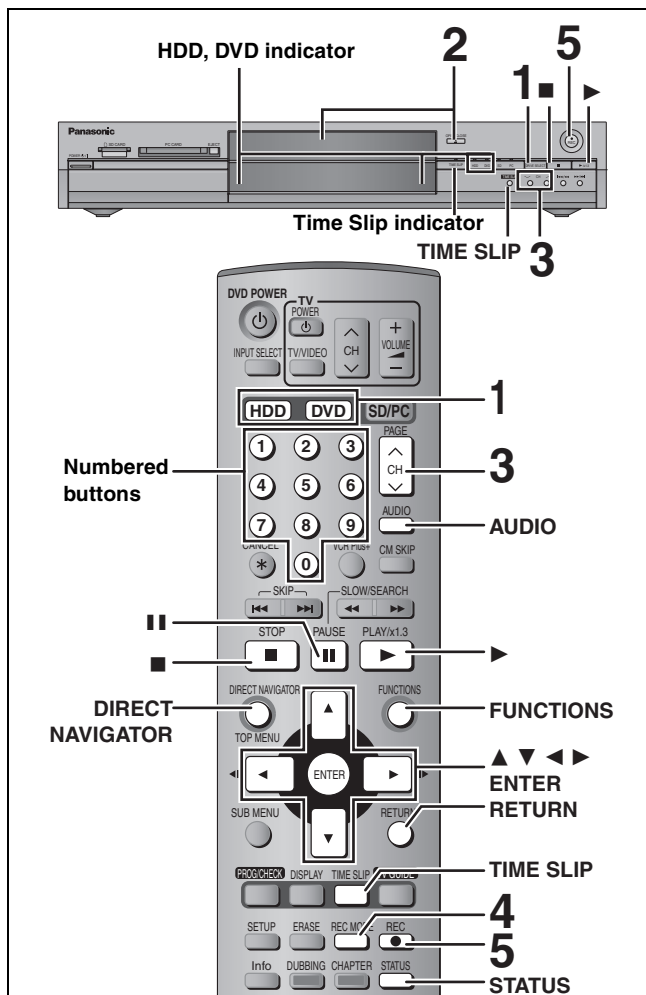

## 1 Press [HDD] or [DVD] to select the recording drive.

The HDD or DVD indicator lights up on the unit.

## 2 If you selected the DVD drive Press [▲ OPEN/CLOSE] on the main unit to open the tray and insert a disc.

• Press the button again to close the tray.

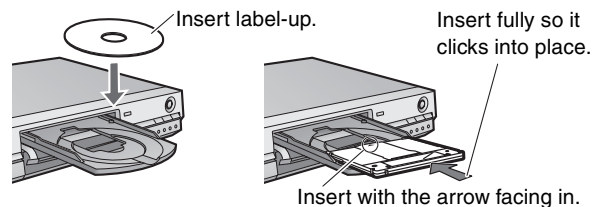

## 3 Press [▲ ▼ CH] to select the channel.



To select with the numbered buttons:

- |                           |                          |
|---------------------------|--------------------------|
| <b>TV Mode (Airwaves)</b> | <b>CATV Mode (Cable)</b> |
| e.g., 5: [0] → [5]        | e.g., 5: [0] → [0] → [5] |
| 15: [1] → [5]             | 15: [0] → [1] → [5]      |
|                           | 115: [1] → [1] → [5]     |

• Select the audio to record (→ page 17).

## 4 Press [REC MODE] to select the recording mode (XP, SP, LP, or EP).



Remaining time on the disc

- To record sound using LPCM (XP mode only): Set "Audio for XP Recording" to "LPCM" in the SETUP menu (→ page 49).

## 5 Press [● REC] to start recording.



Recording will take place on open space on the HDD or on disc. Data will not be overwritten.

- You cannot change the channel or recording mode during recording.

- You can record while the unit is on standby for timer recording, but once the time for the timer recording to begin is reached, any recording taking place will stop and the timer recording will begin.

### ■ To pause recording

Press [II].  
Press again to restart recording.  
(Title is not split into separate titles.)

### ■ To stop recording

Press [■].  
From the start to the end of the recording is called one title.

**HDD**  
When continuously recording for long durations, titles are automatically divided every 8 hours.

**DVD-R**  
It takes about 30 seconds for the unit to complete recording management information after recording finishes.

### HDD RAM DVD-R

- It is not possible to record to both HDD (Hard Disk Drive) and DVD drive simultaneously.
- You can record up to 500 titles on HDD, 99 titles on one disc.
- It is not possible to record continuously from one side of a double sided disc to the other. You will need to eject the disc and turn it over.
- When using 8 cm (3") DVD-RAM, remove the disc from the cartridge.
- It is not possible to record CPRM (→ page 53) protected material onto DVD-R or 2.8 GB DVD-RAM discs.
- It is not possible to record to a card.

### When transferring (dubbing) in high speed mode to DVD-R after you have recorded to the HDD.

Set "DVD-R High-Speed Recording" to "On" before recording to the HDD (→ page 48).

However, the following restrictions apply.

- Even 16:9 aspect (Widescreen) programs are recorded in 4:3 aspect.
- Even if "Hybrid VBR Resolution" is set to "Automatic", it changes to "Fixed" automatically (→ page 48).

### When recording to DVD-R

- When recording MTS broadcasts
  - If you do not connect a cable TV box  
Select "Main" or "SAP" in "Select MTS" in the SETUP menu (→ page 48).
  - If you connect a cable TV box  
Select "Main" or "SAP" on the cable TV box.
- In order to play a DVD-R recorded using this unit on another playback source, the disc must first be finalized (→ page 45).

### Preparation

Press [RETURN] to exit the television program list if it is displayed on the television. To turn off auto start up of the television program list → page 23, "Review options" menu



## ■ To specify a time to stop recording—One Touch Recording

### During recording

Press [● REC] to select the recording time.

Each time you press the button:

0:30 → 1:00 → 1:30 → 2:00 → 3:00 → 4:00  
 ↑ Counter (cancel) ↓

- This does not work during timer recordings (⇒ page 19) or while using Flexible Recording (⇒ page 18).

### To stop recording partway

Press [■].

### Off Timer

The unit switches to standby after about 6 hours in the stop mode. You can turn this feature off or change the time to 2 hours (⇒ page 47, "Off Timer").

## Recording modes and approximate recording times

Depending on the content being recorded, the recording times may become shorter than indicated.

(Unit: hour)

Mode	HDD (160 GB)	DVD-RAM		DVD-R (4.7 GB)
		Single-sided (4.7 GB)	Double-sided (9.4 GB)	
XP (High quality)	36	1	2	1
SP (Normal)	70	2	4	2
LP (Long play)	138	4	8	4
EP (Extra long play)	284 (212*)	8 (6*)	16 (12*)	8 (6*)

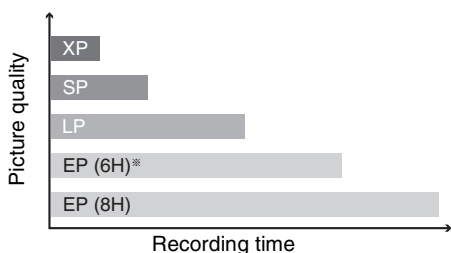

\* When "Recording Time in EP Mode" is set to "EP (6H)" in the SETUP menu. The sound quality is better when using "EP (6H)" than when using "EP (8H)".

### Note

When recording to DVD-RAM using EP (8H) mode, play may not be possible on DVD players that are compatible with DVD-RAM. In this case use EP (6H) mode.

### FR (Flexible Recording Mode)

The unit automatically selects a recording rate between XP and EP (8H) that will enable the recordings to fit in the remaining disc space with the best possible recording quality.

- You can set when transferring (dubbing) or programming timer recordings.
- When recording to the HDD, picture quality is automatically adjusted to precisely fit a transferred (dubbed) title on a 4.7 GB disc.
- All the recording modes from XP to EP appear in the display.



## Selecting audio to record

HDD RAM

Press [AUDIO].

- **Stereo:** Main audio (stereo)
    - If the broadcast is "Mono+SAP", audio will be monaural even if you select Stereo mode.
  - ↓
  - SAP:** Secondary audio program (SAP)
    - If recorded in SAP mode, main audio is also recorded.
  - ↓
  - Mono:** Main audio (monaural)
    - Select "Mono" if reception is poor during a stereo broadcast.
- e.g., "Stereo" is selected  
 ("(" appears when the unit is receiving the audio type you selected.

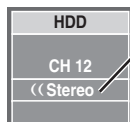

- If you change the sound setting while recording, the recorded sound will also change.

DVD-R

HDD RAM (When recording sound in LPCM)

HDD RAM (When "DVD-R High-Speed Recording" is set to "On")

Select the audio (Main or SAP) in "Select MTS" in the SETUP menu (⇒ page 48).

Refer to the control reference on page 16.

**HDD RAM**

## Playing while you are recording

You can change the drive and play while recording on this unit. Also, while recording to the HDD or to DVD-RAM you can view the title being recorded from the beginning as well as play a recorded title.

### Playing from the beginning of the title you are recording—Chasing playback

#### Press [▶] (PLAY).

Time Slip indicator on the main unit lights.

### Playing a title previously recorded while recording—Simultaneous rec and play

#### 1 Press [DIRECT NAVIGATOR].

#### 2 Press [▲, ▼, ◀, ▶] to select a title and press [ENTER].

Time Slip indicator on the main unit lights.

To exit the Direct Navigator screen

Press [DIRECT NAVIGATOR].

### Reviewing the recorded images while recording—Time Slip

#### 1 Press [TIME SLIP].

Time Slip indicator on the main unit lights.

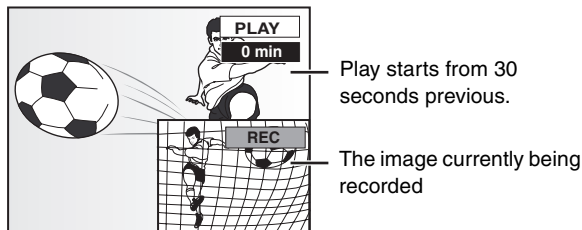

- You will hear the playback audio.

#### 2 Press [▲, ▼] to select the time and press [ENTER].

- Press [TIME SLIP] to show the play images in full. Press again to show the play and recording images.

#### ■ To stop play

Press [■].

#### ■ To stop recording

2 seconds after play stops

Press [■].

#### ■ To stop timer recording

Press [■], then [ENTER] within 5 seconds.

- You can also press and hold [■] on the main unit for more than 3 seconds to stop recording.

**HDD RAM DVD-R**

## Flexible Recording

The unit sets the best possible picture quality that fits the recording within the remaining disc space. The recording mode becomes FR mode.

e.g.,

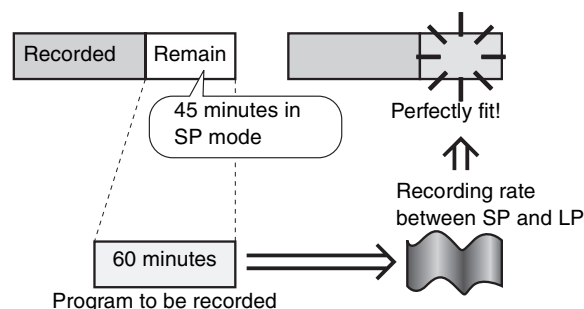

#### Preparation

- Select the channel to record.
- Press [HDD] or [DVD] to select the recording drive.

#### 1 While stopped Press [FUNCTIONS].

#### 2 Press [▲, ▼, ◀, ▶] to select “FLEXIBLE RECORDING” and press [ENTER].



#### 3 Press [◀, ▶] to select “Hour” and “Min.” and press [▲, ▼] to set the recording time.

- You can also set the recording time with the numbered buttons.
- You cannot record more than 8 hours.

#### 4 When you want to start recording Press [▲, ▼, ◀, ▶] to select “Start” and press [ENTER]. Recording starts.

To exit the screen without recording

Press [RETURN].

To stop recording partway

Press [■].

To show the remaining time

Press [STATUS].



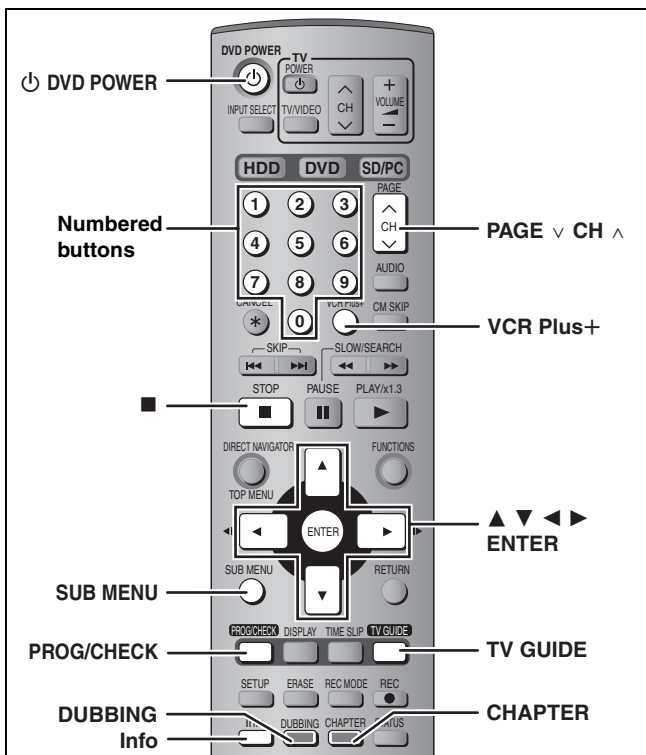

HDD | RAM | DVD-R

## Using the TV Guide On Screen™ system to make timer recordings

You can perform timer recording easily by just marking the desired program(s) in a television program list.

- You can enter up to 8 days in advance.
- The program name becomes the recorded title if the program is listed on the television program list.

### 1 Press [TV GUIDE].

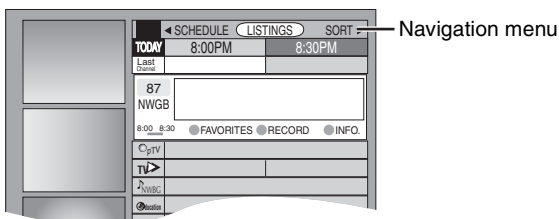

### 2 Press [▲, ▼, ◀, ▶] to select the program.

- To skip one screen  
Press [PAGE v CH ^].
- To skip 24 hours in the list  
Press [▲, ▼, ◀, ▶] to select "LISTINGS" and:  
Press [CHAPTER] (Green) (forward).  
Press [DUBBING] (Blue) (backward).

### 3 Press [CHAPTER] (Green).

"R" appears in the list to indicate that the program is set for timer recording.

- Press [CHAPTER] (Green) to cancel.
- Press [DUBBING] (Blue) to change recording frequency.

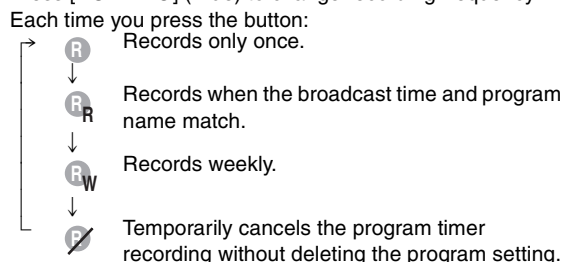

Repeat steps 2–3 to program other recordings.

- As long as the setting is not changed, the program is recorded to the HDD in the recording mode selected by the unit. To change the setting → below.

#### ■ To change the setting

- 1 Press [SUB MENU] to go to the Navigation menu.
- 2 Press [◀, ▶] to select "SCHEDULE".
- 3 Press [▲, ▼] to select the program and press [ENTER].

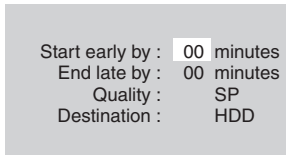

- 4 Change the setting as necessary and press [ENTER].

- To set recording to start early or end late  
Press [▲, ▼] to select "Start early by" or "End late by" and press the numbered buttons to enter minutes (up to 99).

- To change the recording mode  
Press [▲, ▼] to select "Quality" and press [DUBBING] (Blue).

Each time you press the button:  
LP → EP → FR → XP → SP

- To change the recording drive  
Press [▲, ▼] to select "Destination" and press [DUBBING] (Blue).  
Each time you press the button:  
HDD ↔ DVD

When the recording drive is "DVD" and there is not enough remaining space, recording automatically switches to the "HDD" (→ page 21, Relief Recording).

### 4 Press [TV GUIDE].

- Returns to the television screen.
- The unit is not off. To save power, turn the unit off by pressing [DVD POWER].
- When using the cable TV box, make sure the cable TV box is turned on.

To check, change or delete the program → page 21  
To utilize TV Guide On Screen™ system, see also page 22.  
Notes on timer recording → page 21

#### ■ To cancel recording when recording has already begun

- Press [■], then [ENTER] within 5 seconds.
- You can also press and hold [■] on the main unit for more than 3 seconds to stop recording.

- There may be some channels that are not displayed in the television program list even if they are receivable. In this case set them manually (→ page 20).



## 4 Press [ENTER].

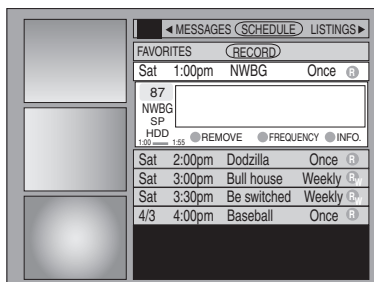

Repeat steps 1–4 to program other recordings.

- As long as the setting is not changed, the program is recorded to the HDD in the recording mode selected by the unit. To change the setting → page 19, To change the setting, steps ③–④.

## 5 Press [TV GUIDE].

Returns to the television screen.

- The unit is not off. To save power, turn the unit off by pressing [⏻ DVD POWER].
- When using the cable TV box, make sure the cable TV box is turned on.

### ■ To cancel recording when recording has already begun

Press [■], then [ENTER] within 5 seconds.

- You can also press and hold [■] on the main unit for more than 3 seconds to stop recording.

## Check, change or delete a program

### 1 Press [PROG/CHECK].

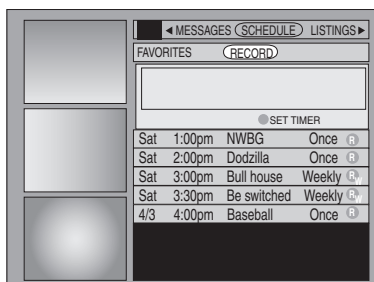

### 2 Press [▲, ▼] to select the program.

Channel or program name (a program name that was set for timer recording using TV Guide On Screen™ system or VCR Plus+ system that was listed in the program list)

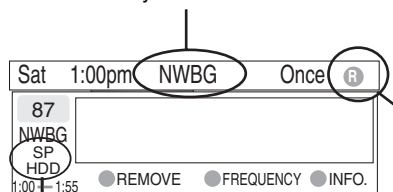

Recording mode (→ page 17)      Frequency (→ page 19, 20)  
Recording drive

### ■ To change the recording frequency

Press [CHAPTER] (Green).

### ■ To change the time, recording mode and recording drive

Press [ENTER]. (→ page 19, To change the setting, step ④)

### ■ To delete the program

Press [DUBBING] (Blue).

### ■ To exit the screen

Press [TV GUIDE].

Returns to the television screen.

- The unit is not off. To save power, turn the unit off by pressing [⏻ DVD POWER].

### ■ When there is a duplicate or overlapping program timer recording

The program timer recording that was set last is recorded. None of the program that was set earlier is recorded even if there is only partial overlapping.

Program timer recordings that are not recorded are highlighted in grey.

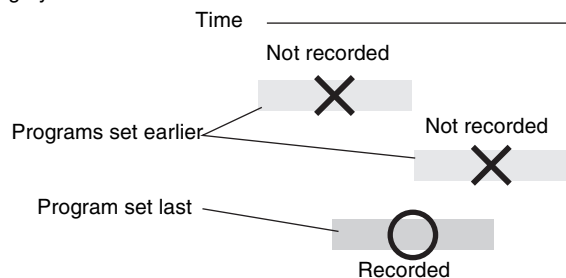

### Notes on timer recording

- “Ⓢ” lights on the unit’s display to indicate that the unit is in timer recording standby.
- “Ⓢ” flashes when the unit cannot go to timer recording standby.
- Timer recordings are activated regardless of whether the unit is turned on/off.
- Timer recordings begin when the set time is reached even when recording or when playing.
- Timer recordings do not begin while transferring (dubbing) in normal speed mode (→ page 37).
- When you program successive timer recordings to start immediately one after the other, the unit cannot record the part at the ending of the earlier program (approximately 15 seconds). In addition, when recording to DVD-R, the unit cannot record the part at the beginning of the later program (approximately 15 seconds).

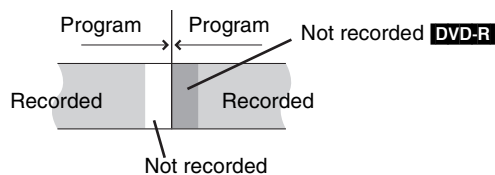

- If you set DST (Daylight Saving Time) to ON when manually setting the clock (→ page 11), timer recording may not work when summer switches to winter and vice versa.

### ■ Relief Recording

When the recording drive is set to “DVD” for timer recording and if the program will not fit onto the disc, the recording drive will be changed to the “HDD” automatically.

- If there is no disc in the tray or the disc cannot be recorded on or when timer recording starts while transferring (dubbing), the recording drive will be changed to the HDD.
- The Direct Navigator shows which programs were relief-recorded (“↔” is displayed.) (→ page 24).
- If the time remaining on the HDD is insufficient, as much of the program as possible will be recorded onto the HDD.

Refer to the control reference on page 19.

## 1 Press [TV GUIDE].

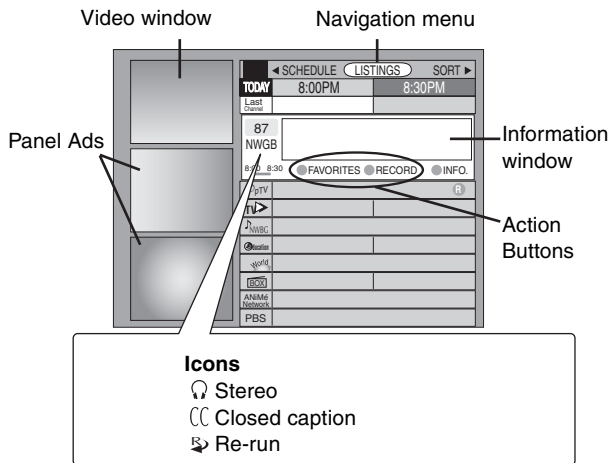

Programs are categorized by color.

Green: Sports      Blue: Children's  
Purple: Movies      Teal: Other categories

## 2 Press [SUB MENU] to go to the Navigation menu.

## 3 Press [◀, ▶] to select the item and press [▼].

One of the following screens will appear depending on the item selected.

LISTINGS      SORT      SCHEDULE  
SETUP      MESSAGES      PROMOTIONS

### Common operations

[▲, ▼, ◀, ▶] [ENTER]	Select/Enter
[PAGE v CH ^]	Skip one screen
[SUB MENU]	Move to the Navigation menu
[CHAPTER]	“Green” Action Button The Action Button functions will be displayed on the screen.
[DUBBING]	“Blue” Action Button The Action Button functions will be displayed on the screen.
[Info]	Change the size of information window

### LISTINGS screen

The LISTINGS screen displays the station, title, time, length, contents and ratings. It allows you to scroll through current and future program listings and register them for recording or as a “Favorite”, and jump directly to the program channel through a one-touch button.

### Functions of Action Buttons

+24 Hours:	Skip 24 hours forward
-24 Hours:	Skip 24 hours backward
LOCK:	Lock the program currently selected in the Video Window
UNLOCK:	The Video Window display will change as different programs are highlighted
RECORD:	Record this program (⇒ page 19, Step 3)
FAVORITE:	Register this program as a “Favorite” (⇒ right)
CANCEL REC./ CANCEL FAV.:	Cancel recording or a “Favorite”
FREQUENCY:	Change the frequency of recording or a “Favorite”

## ■ Registering a program you don't want to miss as a “Favorite”

By registering a program as a “Favorite”, you can later tune to that program quickly by pressing [DUBBING] (Blue) when that program begins broadcasting.

When watching TV, we recommend you occasionally press [DUBBING] (Blue). This unit may tune into a “Favorite” program that you had forgotten about.

### To register a program as a “Favorite”

Press [DUBBING] (Blue) on the program.

“♥” appears in the list to indicate that the program is set as a “Favorite”.

• Press [CHAPTER] (Green) to change the frequency.

Each time you press the button:

↓ ♥ Registers as a “Favorite” only once.

↓ ♥ R A program becomes a “Favorite” when the broadcast time and program name match.

↓ ♥ W Registers as a “Favorite” weekly.

↓ ✂ “Favorite” registration temporarily off.

• Press [DUBBING] (Blue) to cancel.

Repeat the above to set other programs.

• When there is more than one program registered as “Favorite” in the same time frame, each time you press [DUBBING] (Blue), the program switches to the other.

### SORT screen

The SORT screen displays program listings sorted into your preferred categories. You can register programs on the list for recording or as a “Favorite”, and jump directly to the program channel through a one-touch button.

There are various categories, such as movies, sports, children's, educational, news, variety, series, HDTV, and alphabetically. Each category will contain individual sub-categories.

- 1 Press [◀, ▶] to select the major category and press [▼].
- 2 Press [▲, ▼, ◀, ▶] to select the minor category and press [ENTER].
- 3 Press [▲, ▼, ◀, ▶] to select a program.
  - When sorting alphabetically, programs with the same name (such as reruns or subsequent broadcasts of the same program) are displayed together in one column. In this case, press [▲, ▼] to select a program name and press [ENTER]. Each broadcast of the program is then displayed separately. Press [▲, ▼] to select the desired program.

### Functions of Action Buttons

RECORD:	Record this program (⇒ page 19, Step 3)
FAVORITE:	Register this program as a “Favorite” (⇒ above)
CANCEL REC./ CANCEL FAV.:	Cancel recording or a “Favorite”
FREQUENCY:	Change the frequency of recording or a “Favorite”

### SCHEDULE screen

The SCHEDULE screen displays programs registered for recording or as a “Favorite” separately on the list. In addition to being able to review the list, you can also remove programs and change the frequency or modify the start/end times (only when recording) of programs selected.

### Functions of Action Buttons

SET TIMER:	Show the manual timer recording screen (⇒ page 20, Step 3)
CANCEL:	Cancel an entry on the manual timer recording screen
FREQUENCY:	Change the frequency of recording or a “Favorite”
REMOVE/STOP	Remove the timer or “Favorite” program/ Stop timer recording

## SETUP screen

The SETUP screen allows you to redo the channel settings, customize the channel line-up and set the TV Guide On Screen™ system's start-up pattern.

### ■ “Change system settings” menu–Access to the TV Guide On Screen™ system setup screen

You can also verify any information entered during setup, or completely redo the setup, for the TV Guide On Screen™ system.

- Press [▲, ▼] to select “Change system settings” and press [ENTER].  
The information that was set is displayed, and you are asked to confirm whether it is correct.

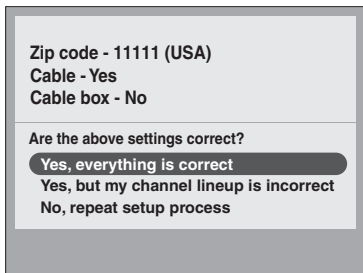

- Press [▲, ▼] to select the message and press [ENTER].
  - “Yes, everything is correct”  
–The information that was set will remain intact. Press [ENTER] again to exit the screen.
  - “Yes, but my channel lineup is incorrect”  
–You can customize the channel line-up in the CHANNEL EDITOR screen (⇒ below). Press [▲, ▼] to select “No Match” and press [ENTER].
  - “No, repeat setup process”  
–The TV Guide On Screen™ system setup screen is displayed. Follow the on-screen prompts to redo the setup (⇒ page 10, step 2).

### ■ “Change channel display” menu–CHANNEL EDITOR

The “Change channel display” menu allows you to customize the channel line-up using the CHANNEL EDITOR. You can easily change channel line-up should the cable company occasionally revise their channel assignments.

- Press [▲, ▼] to select “Change channel display” and press [ENTER].
- Press [▲, ▼] to select the channel.
  - Press [PAGE ∨ CH ∧] to skip one screen.
- Customize the channel as follows.

#### To display/hide the channel

Press [CHAPTER] (Green) to select “ON” (display) or “OFF” (hide).

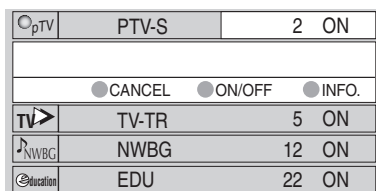

CHANNEL EDITOR screen

#### To change the channel number

Press the numbered buttons.

- e.g. 1: [0] ⇒ [0] ⇒ [1]  
 15: [0] ⇒ [1] ⇒ [5]  
 115: [1] ⇒ [1] ⇒ [5]

#### To change the order of the channels

- Press [◀].
- Press [DUBBING] (Blue) to move up or [CHAPTER] (Green) to move down.

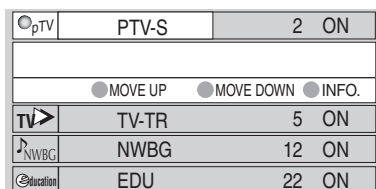

Repeat steps 2–3 as necessary.

- Press [TV GUIDE].

### ■ “Review options” menu–Selecting the TV Guide On Screen™ system start up pattern

- Press [▲, ▼] to select “Review options” and press [ENTER].
- Press [▲, ▼] to select the option and press [ENTER].
  - On: Turns on auto start up.
  - Off: Turns off auto start up.

## MESSAGES screen

The MESSAGES screen is where additional product program or other information can be received and displayed by the TV Guide On Screen™ system. If major changes to the program listings are scheduled to be made, it will be displayed in the message section. The serial number specific to your TV Guide On Screen™ system can also be found on this screen.

When there are unread messages, an envelope-shaped icon appears at the upper left of the screen. 

#### To read a message

Press [▲, ▼] to select the message and press [Info].

- To delete unwanted messages press [CHAPTER] (Green).
- Messages are automatically deleted after 60 days.

## PROMOTIONS screen

The PROMOTIONS screen provides you with a list of promotional items that have appeared as Panel Ads or Channel banners during the current day. Promotions are updated daily during pre-designated download times.

#### To read a promotion

Press [▲, ▼] to select the item and press [Info].

#### Functions of Action Buttons

(When the TV program item is highlighted)

RECORD:	Record this program (⇒ page 19, Step 3)
FAVORITE:	Register this program as a “Favorite” (⇒ page 22)

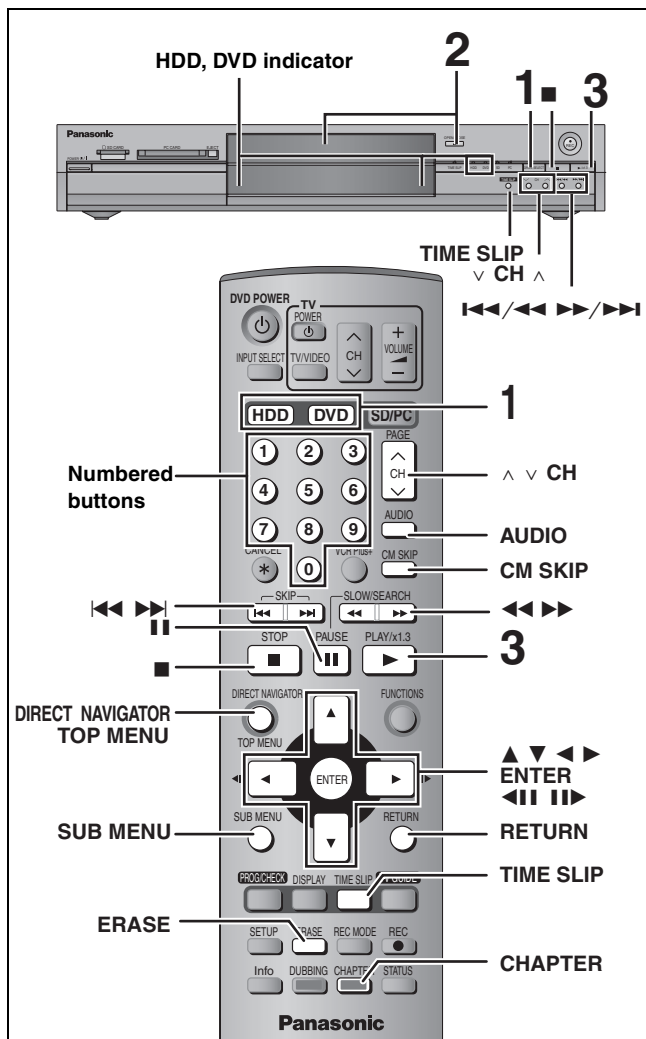

- It is possible to watch playback from one drive while recording on another (editing is not possible).
- It is not possible to play continuously from one side of a double sided disc to the other. You will need to eject the disc and turn it over.
- When using 8 cm (3") DVD-RAM, remove the disc from the cartridge.

### Preparation

Press [RETURN] to exit the television program list if it is displayed on the television. To turn off auto start up of the television program list → page 23, "Review options" menu

## 1 Press [HDD] or [DVD] to select the playback drive.

The HDD or DVD indicator lights up on the unit.

## 2 If you selected the DVD drive

Press [▲ OPEN/CLOSE] on the main unit to open the tray and insert a disc.

- Press the button again to close the tray.

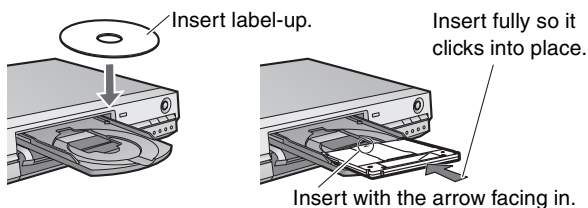

## 3 Press [▶] (PLAY).

**HDD RAM DVD-R**

Play starts from the most recently recorded title.

**DVD-A DVD-V VCD CD**

Play starts from the beginning of the disc.



### ■ Selecting recorded programs (titles) to play—Direct Navigator

**HDD RAM DVD-R**

#### 1 Press [DIRECT NAVIGATOR].

• Thumbnail Display

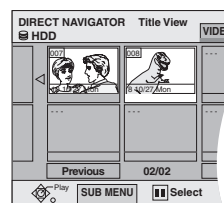

• Table Display

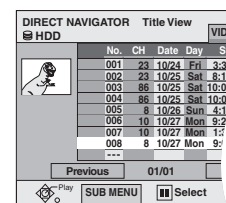

#### Switching the Direct Navigator appearance

- ① Press [SUB MENU] while Thumbnail Display is displayed.
- ② Press [▲, ▼] to select "Table Display" and press [ENTER].

• The display appearance last used is saved even after the unit is turned off.

#### 2 **HDD RAM**

Press [▲, ▼, ◀, ▶] to select "VIDEO" tab and press [ENTER].



#### 3 Press [▲, ▼, ◀, ▶] to select the title and press [ENTER].

You can also select titles with the numbered buttons.

e.g., **HDD** 5: [0] → [0] → [5] 15: [0] → [5]  
 15: [0] → [1] → [5] 15: [1] → [5]  
 115: [1] → [1] → [5]

#### To show other pages

Press [▲, ▼, ◀, ▶] to select "Previous" or "Next" and press [ENTER].

- You can also press [◀◀, ▶▶] to show other pages.

#### To exit the screen

Press [DIRECT NAVIGATOR].

#### Direct Navigator screen icons

- 🔒 Title protected.
- 📄 Title that was not recorded due to recording protection (Digital broadcasts, etc.)
- ✗ Title cannot be played [When transferring (dubbing) a title to the HDD, or when data is damaged, etc.]
- Currently recording.
- ➡ Titles that have been rerouted to the HDD (→ page 21, Relief Recording)
- 📁 Title with "One time only recording" restriction

### ■ When a menu screen appears on the television

**DVD-A DVD-V**

Press [▲, ▼, ◀, ▶] to select the item and press [ENTER]. Some items can also be selected using the numbered buttons.

**VCD**

Press the numbered buttons to select the item.

e.g., 5: [0] → [5] 15: [1] → [5]

#### • To return to the menu screen



**DVD-A** Press [TOP MENU].

**DVD-V** Press [TOP MENU] or [SUB MENU].

**VCD** Press [RETURN].

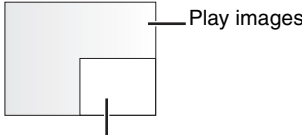

## Operations during play

<p>Stop</p>	<p><b>Press [■].</b> The stopped position is memorized. “PLAY” flashes in the unit’s display. (Excluding when playing from the Direct Navigator and when playing a play list.) <b>Resume play function</b> Press [▶] (PLAY) to restart from this position.</p>	
<p>Pause</p>	<p><b>Press [⏸].</b> Press again to restart play.</p>	
<p>Search</p>	<p><b>Press [◀◀] or [▶▶].</b></p> <ul style="list-style-type: none"> <li>•On the main unit, press and hold [◀◀/▶▶] or [▶▶/▶▶].</li> <li>•The speed increases up to 5 steps.</li> <li>•Press [▶] (PLAY) to restart play.</li> <li>•Audio is heard during first level search forward.</li> </ul> <p>You can turn off the sound during search (⇒ page 48, “Search Audio &amp; PLAY ×1.3”). Audio is heard during all levels of search. <b>DVD-A</b> (excluding moving picture parts) <b>CD</b></p>	
<p>Skip</p>	<p><b>Press [◀◀] or [▶▶].</b></p> <ul style="list-style-type: none"> <li>•On the main unit, press [◀◀/▶▶] or [▶▶/▶▶].</li> <li>•Each press increases the number of skips.</li> </ul>	
<p>Starting from a selected item</p>	<p><b>Press the numbered buttons.</b> e.g., 5: [0] ⇒ [5] <b>HDD</b> <b>CD</b> (MP3 discs only) 5: [0] ⇒ [0] ⇒ [5] 15: [1] ⇒ [5] 15: [0] ⇒ [1] ⇒ [5]</p> <p><b>DVD-A</b> Selecting groups While stopped (screen saver is displayed on the television ⇒ right) 5: [5]</p> <ul style="list-style-type: none"> <li>•This works only when stopped (screen saver is displayed on the television ⇒ right) with some discs.</li> </ul>	
<p>Quick View <b>HDD</b> <b>RAM</b> The play speed can be increased without distorting the audio.</p>	<p><b>Press and hold [▶] (PLAY/×1.3).</b></p> <ul style="list-style-type: none"> <li>•Press again to return to normal speed.</li> <li>•This does not work if the setting is “Off” in “Search Audio &amp; PLAY ×1.3” (⇒ page 48).</li> </ul>	
<p>Slow-motion <b>HDD</b> <b>RAM</b> <b>DVD-R</b> <b>DVD-A</b> (Motion picture parts only) <b>DVD-V</b> <b>VCD</b></p>	<p><b>While paused, press [◀◀] or [▶▶].</b></p> <ul style="list-style-type: none"> <li>•On the main unit, press and hold [◀◀/▶▶] or [▶▶/▶▶].</li> <li>•The speed increases up to 5 steps.</li> <li>•Press [▶] (PLAY) to restart play.</li> <li>•Forward direction only. <b>VCD</b></li> <li>•The unit will pause if slow-motion play is continued for 5 minutes.</li> </ul>	
<p>Frame-by-frame <b>HDD</b> <b>RAM</b> <b>DVD-R</b> <b>DVD-A</b> (Motion picture parts only) <b>DVD-V</b> <b>VCD</b></p>	<p><b>While paused, press [◀◀] or [▶▶].</b></p> <ul style="list-style-type: none"> <li>•Each press shows the next frame.</li> <li>•Press [▶] (PLAY) to restart play.</li> <li>•Forward direction only. <b>VCD</b></li> </ul>	
<p>Displaying the television image as a picture-in-picture</p> <p>Skipping the specified time (Time Slip)</p> <p><b>HDD</b> <b>RAM</b> <b>DVD-R</b></p>	<p><b>Press [TIME SLIP].</b> The unit displays the television image as a picture-in-picture.</p> <ul style="list-style-type: none"> <li>•You will hear the playback audio.</li> <li>•Press [TIME SLIP] again to cancel.</li> <li>•The blue background does not appear on the receiving screen even if you select “On” from the “Blue Background” in the SETUP menu (⇒ page 49).</li> </ul> <p><b>1 Press [TIME SLIP].</b> <b>2 Press [▲, ▼] to select the time and press [ENTER].</b> Play skips the specified time.</p> <ul style="list-style-type: none"> <li>•Press [TIME SLIP] to show the play images in full.</li> </ul>	 <p>Play images</p> <p>Current receiving images</p> <ul style="list-style-type: none"> <li>•You can change the channel being received by pressing [^ v CH].</li> <li>•You cannot change the channel being received while recording.</li> </ul>
<p>CM Skip <b>HDD</b> <b>RAM</b> <b>DVD-R</b> Play restarts from approximately a minute later.</p>	<p><b>Press [CM SKIP].</b></p>	

Refer to the control reference on page 24.

## Editing operations during play

### Erase

HDD RAM DVD-R

- 1 Press [ERASE].
- 2 Press [◀, ▶] to select "Erase" and press [ENTER].

- A title cannot be restored once it is erased. Make certain before proceeding.
- You cannot erase while recording or transferring (dubbing).

### Create chapters

(⇒ page 32, Title/Chapter)

HDD RAM

#### Press [CHAPTER].

- Press [◀◀, ▶▶] to skip to the start of a chapter.
- You cannot divide while recording or transferring (dubbing).

Playing back

## Changing audio during play

### Press [AUDIO].

HDD RAM VCD

LR→L→R  
↑

e.g., "L R" is selected

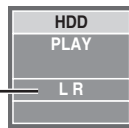

- When playing an SAP broadcast recorded on DVD-RAM: MAIN ↔ SAP

DVD-A DVD-V

You can change the audio channel number each time you press the button. This allows you to change things like the soundtrack language (⇒ page 30, Sound track).



e.g., English is selected.

#### Note

You cannot change the audio type in the following cases.

- When a DVD-R disc is in the disc tray while DVD drive is selected.
- When the recording mode is XP and "Audio for XP Recording" is set to "LPCM" (⇒ page 49).
- When "DVD-R High-Speed Recording" is set to "On" (⇒ page 48).

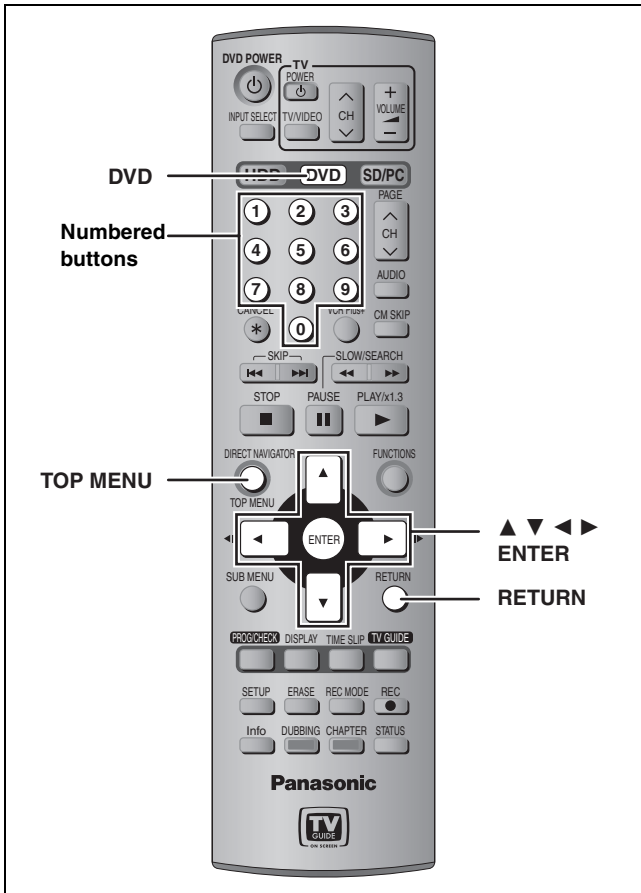

**CD** (MP3 discs only)

This unit plays MP3 files recorded on CD-R/RW designed for audio recording that are finalized (→ page 53) on a computer. Files are treated as tracks and folders are treated as groups.

### Preparation

Press [DVD] to select the DVD drive.

## 1 Press [TOP MENU].

**G:** Group No.  
**T:** Track No. in the group  
**TOTAL:** Track No./Total tracks in all groups

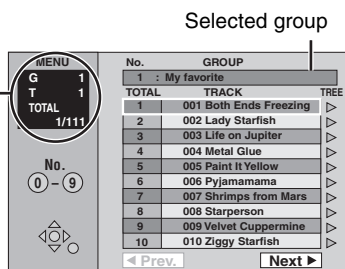

## 2 Press [▲, ▼] to select the track and press [ENTER].

Play continues to the last track in the last group.

- “” indicates the track currently playing.
- You can also select the track with the numbered buttons.  
 e.g., 5: [0] → [0] → [5]  
 15: [0] → [1] → [5]

### To show other pages

Press [▲, ▼, ◀, ▶] to select “Prev.” or “Next” and press [ENTER]. After listing all the tracks in one group, the list for the next group appears.

### To exit the screen

Press [TOP MENU].

## Using the tree screen to find a group

While the file list is displayed

### 1 Press [▶] while a track is highlighted to display the tree screen.

**Selected group No. /Total groups**

If the group has no track, “-” is displayed as group number.

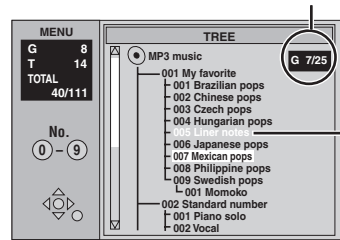

You cannot select groups that contain no compatible files.

### 2 Press [▲, ▼, ◀, ▶] to select a group and press [ENTER].

The file list for the group appears.

### To return to the file list

Press [RETURN].

### Tips for making MP3 discs

- Discs must conform to ISO9660 level 1 or 2 (except for extended formats).
- Compatible compression rate: between 32 kbps and 320 kbps
- Compatible sampling rate:  
16 kHz, 22.05 kHz, 24 kHz, 32 kHz, 44.1 kHz and 48 kHz
- Maximum number of tracks and groups recognizable:  
999 tracks and 99 groups
- This unit is compatible with multi-session.
- This unit is not compatible with ID3 tags or packet writing.
- Depending on recording, some items may not be playable.
- Reading or play of the disc may take time if there are a lot of still pictures or sessions.
- The display order may differ from how the order is displayed on a computer.

### Naming folders and files

- MP3 files must have the extension “.MP3” or “.mp3”.
- At the time of recording, give folder and file names a 3-digit numeric prefix in the order you want them to play (this may not work at times).
- English alphabets and Arabic numerals are displayed correctly. Other characters may not be displayed correctly.

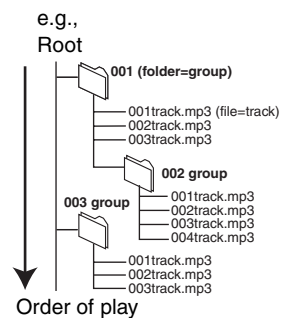

# Playing still pictures

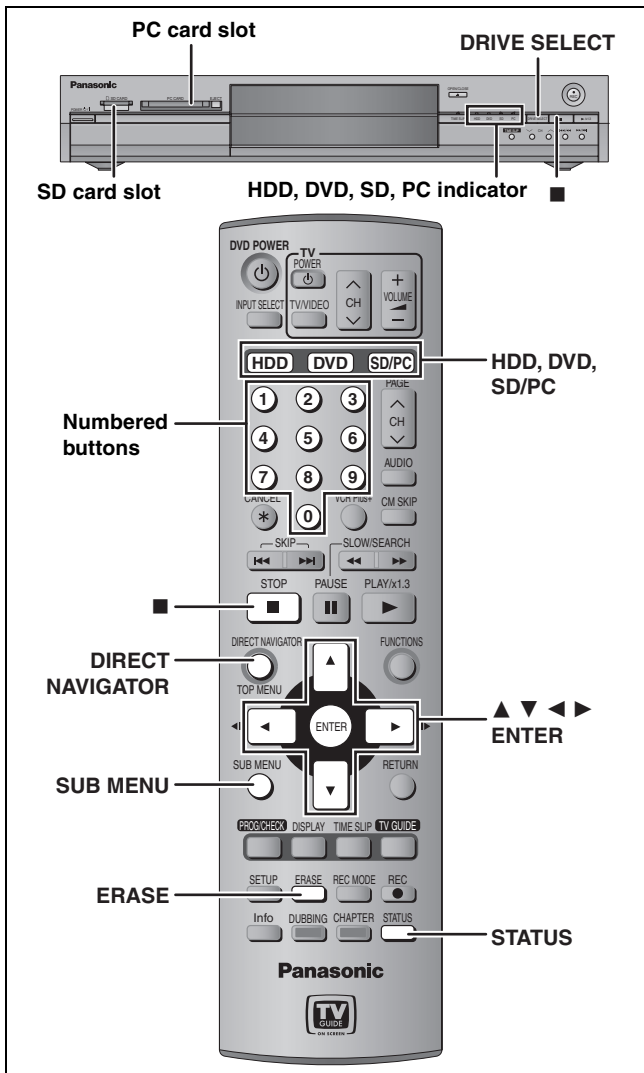

## Inserting/Removing the SD/PC card

Only insert or remove the SD/PC card after turning the unit off. When the card indicator ("SD" or "PC") on the unit's display is flashing, the card is being read from or written to. Do not turn off the unit or remove the card. Such action may result in malfunction or loss of the card's contents.

### SD card slot

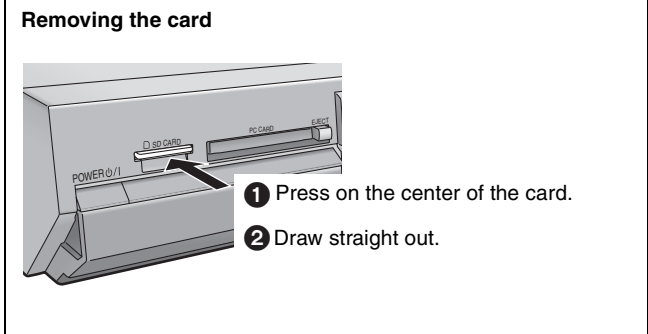
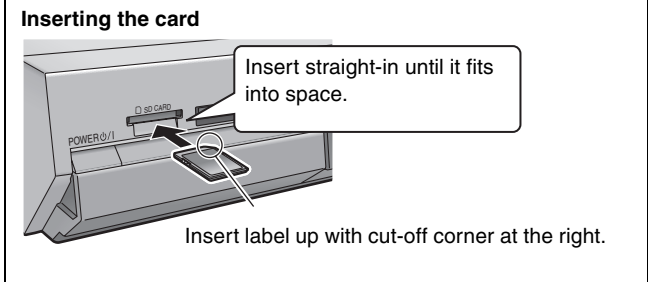

### PC card slot

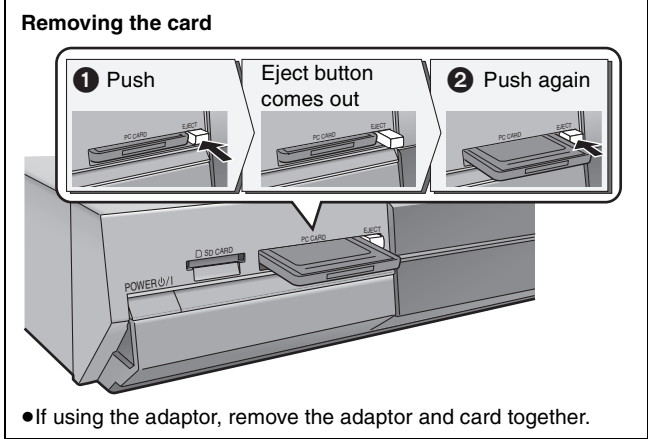
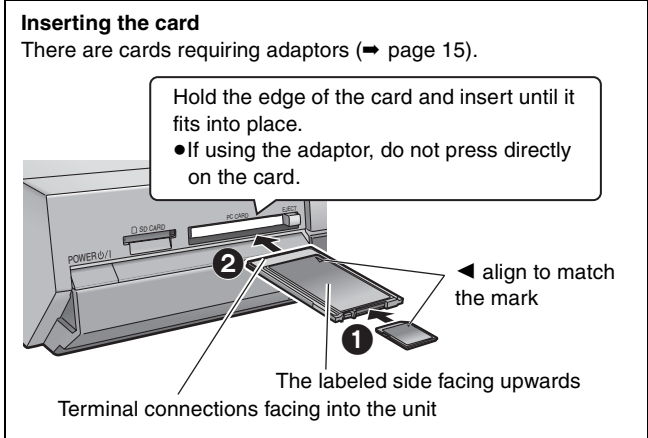

### Regarding still pictures (JPEG, TIFF)

- Compatible formats: DCF\* compliant (Content recorded on a digital camera etc.)
  - \* Design rule for Camera File system: unified standard established by Japan Electronics and Information Technology Industries Association (JEITA).
- File format: JPEG, TIFF (non-compressed RGB chunky format)
- Number of pixels: 34×34 to 6144×4096 (Sub sampling is 4:2:2 or 4:2:0)
- This unit can handle a maximum of 3000 files and 300 folders (including higher folders).
- Operation may take time to complete when playing TIFF format still pictures, or when there are many files and/or folders, some files may not display or be playable.
- MOTION JPEG is not supported.

# 1 Press [HDD], [DVD] or [SD/PC] to select the drive.

- Each time you press [SD/PC]:  
SD card drive ↔ PC card drive
- On the main unit, press [DRIVE SELECT] several times.  
The indicator lights up on the unit.

e.g., SD card drive



# 2 Press [DIRECT NAVIGATOR].

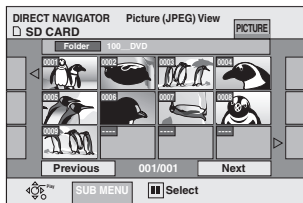

Picture (JPEG) View screen

# 3 Press [▲, ▼, ◀, ▶] to select "PICTURE" tab and press [ENTER].

# 4 Press [▲, ▼, ◀, ▶] to select the still picture and press [ENTER].

- You can also select still pictures with the numbered buttons.
- e.g.,
- 5: [0] → [0] → [0] → [5]      115: [0] → [1] → [1] → [5]
- 15: [0] → [0] → [1] → [5]      1115: [1] → [1] → [1] → [5]
- Press [◀, ▶] to display the previous or next still picture.
  - Useful functions during still picture play (⇒ below).

### To stop playing

Press [■]

### To exit the screen

Press [DIRECT NAVIGATOR].

## ■ To select the still pictures in another folder

(⇒ page 15, Structure of folders displayed by this unit)

- 1 Press [▲, ▼, ◀, ▶] to select "Folder" and press [ENTER].
- 2 Press [▲, ▼] to select the folder and press [ENTER].

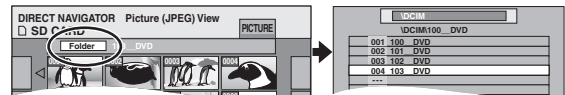

You can also select folders with the numbered buttons.

- e.g., 5: [0] → [0] → [5]  
15: [0] → [1] → [5]  
115: [1] → [1] → [5]

- If there is a multiple number of higher folders recognizable, you can switch them using [◀, ▶].



## ■ To show the picture properties

Press [STATUS] twice.

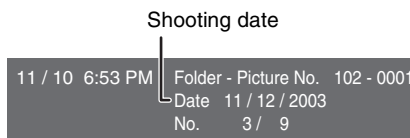

### To exit the picture properties screen

Press [STATUS].

### Note

Still pictures cannot be played during recording or transferring (dubbing).

### Direct Navigator screen icons

- Picture protected.
- Picture in which the number of prints is set (DPOF) (⇒ page 36, 53).

## Useful functions during still picture play

<p><b>Start Slide Show</b> Slide Interval</p>	<p>You can display still pictures one by one with constant interval.</p> <p><b>While the Picture (JPEG) View screen is displayed</b></p> <ol style="list-style-type: none"> <li>1 Press [SUB MENU].</li> <li>2 Press [▲, ▼] to select "Start Slide Show" and press [ENTER].</li> </ol> <ul style="list-style-type: none"> <li>• To change the display timing                     <ol style="list-style-type: none"> <li>1 Press [▲, ▼] to select "Slide Interval" in step 2 and press [ENTER].</li> <li>2 Press [◀, ▶] to select the desired timing (0–30 seconds) and press [ENTER].</li> </ol> </li> </ul>	
<p><b>Rotate</b></p>	<ol style="list-style-type: none"> <li>1 Press [SUB MENU].</li> <li>2 Press [▲, ▼] to select "Rotate RIGHT" or "Rotate LEFT" and press [ENTER].</li> </ol> <ul style="list-style-type: none"> <li>• Rotation information will not be stored.</li> </ul>	
<p><b>Zoom in</b> <b>Zoom out</b> (Only for a still picture with a low pixel count)</p>	<ol style="list-style-type: none"> <li>1 Press [SUB MENU].</li> <li>2 Press [▲, ▼] to select "Zoom in" and press [ENTER].</li> </ol> <ul style="list-style-type: none"> <li>• To return the picture to its original size, press [▲, ▼] to select "Zoom out" in step 2 and press [ENTER].</li> <li>• When zooming in, the picture may be cut off.</li> <li>• The enlargement information will not be stored.</li> </ul>	
<p><b>Erase</b></p>	<ol style="list-style-type: none"> <li>1 Press [ERASE].</li> <li>2 Press [◀, ▶] to select "Erase" and press [ENTER].</li> </ol> <ul style="list-style-type: none"> <li>• Once erased, the recorded contents are lost and cannot be restored. Make certain before proceeding.</li> </ul>	

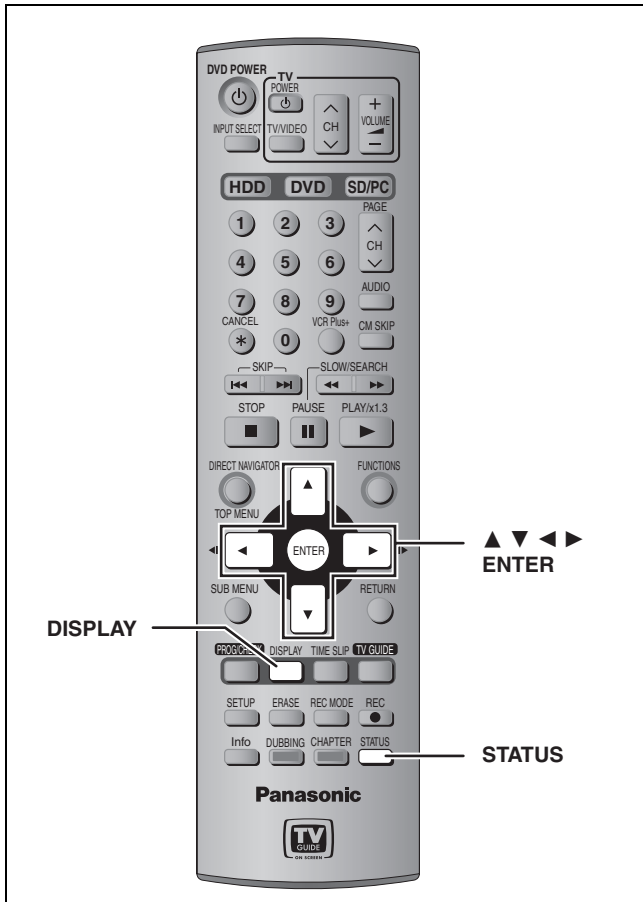

## Disc menu—Setting the disc content

### Sound track\*

**HDD RAM DVD-R**

The disc's audio attributes appear.

**DVD-A DVD-V**

Select the audio and language (➡ below, Audio attribute, Language).

### Subtitle\*

**HDD RAM DVD-R** (Only discs that contain subtitle on/off information)

**DVD-A DVD-V**

Turn the subtitle on/off and select the language (➡ below, Language).

- Subtitle on/off information cannot be recorded using this unit. **HDD RAM DVD-R**
- If the subtitles overlap closed captions recorded on discs, turn the subtitles off.

### Audio channel **HDD RAM VCD**

➡ page 26, Changing audio during play

### Angle\* **DVD-A DVD-V**

### STILL-P (Still picture) **DVD-A**

Selects the play method for still pictures.

**Slide Show:** Plays according to the default order on the disc.

**Page:** Select the still picture number and play.

• **RANDOM:** Plays in random order.

• **Return:** Returns to the default still picture on the disc.

### PBC (Playback control ➡ page 53) **VCD**

Indicates whether menu play (playback control) is on or off.

\* You may have to use the menus (➡ page 24) on the disc to make changes.

• The display changes according to the disc content. You cannot change when there is no recording.

### Audio attribute

LPCM/PPCM/Digital/DTS/MPEG:	Signal type
k (kHz):	Sampling frequency
b (bit):	Number of bits
ch (channel):	Number of channels

### Language

ENG: English	SVE: Swedish	CHI: Chinese
FRA: French	NOR: Norwegian	KOR: Korean
DEU: German	DAN: Danish	MAL: Malay
ITA: Italian	POR: Portuguese	VIE: Vietnamese
ESP: Spanish	RUS: Russian	THA: Thai
NLD: Dutch	JPN: Japanese	*: Others

## On-screen menus

### 1 Press [DISPLAY].

Disc	Sound track	1	DQ Digital	2/0 ch
Play	Subtitle	OFF		
Video	Audio channel	L R		

Menu                      Item                      Setting

- Depending on the condition of the unit (playing, stopped, etc.) and disc contents, there are some items that you cannot select or change.

### 2 Press [▲, ▼] to select the menu and press [▶].

### 3 Press [▲, ▼] to select the item and press [▶].

### 4 Press [▲, ▼] to select the setting.

- Some items can be changed by pressing [ENTER].

### To clear the on-screen menus

Press [DISPLAY].

## Play menu—Change the play sequence

This function works only when the elapsed play time is displayed.

### Repeat play

- All **VCD** **CD** (excluding MP3 discs)
  - Chapter **HDD** **RAM** **DVD-R** **DVD-V**
  - Group **DVD-A** **CD** (MP3 discs only)
  - PL (Play list) **HDD** **RAM**
  - Title **HDD** **RAM** **DVD-R** **DVD-V**
  - Track **DVD-A** **VCD** **CD**
- Select "OFF" to cancel.

## Video menu—Change the picture quality

### Picture

- **Normal:** Default setting
- **Soft:** Soft picture with fewer video artifacts
- **Fine:** Details are sharper
- **Cinema:** Mellows movies, enhances detail in dark scenes.
- **User:** You can make further adjustments.  
Press [**▲**, **▼**, **◀**, **▶**] to select "Detail picture adjustment" and press [ENTER].

#### Contrast

Increases the contrast between light and dark parts of the picture.

#### Brightness

Brightens the picture.

#### Sharpness

Adjust the sharpness of the edges of the horizontal lines.

#### Color

Adjusts the shade of the picture's color.

#### Gamma

Increases the brightness of the center ranges to improve detail and contrast in dark scenes.

#### 3D NR

Reduces overall noise.

#### Integrated DNR

Reduces mosaic noise and character smudging.

### MPEG-DNR (When any item other than "User" is selected)

You can turn the recommended settings for 3D NR and Integrated DNR on and off.

### Progressive\* (⇒ page 53)

Select "ON" to enable progressive output.

- Select "OFF" if the picture is stretched horizontally.
- When progressive output is on, closed captions cannot be displayed.

### Transfer\* [When "Progressive" (⇒ above) is set to "ON".]

Select the method of conversion for progressive output to suit the type of material being played (⇒ page 53, Film and video).

- **Auto1 (normal):**  
Detects 24 frame-per-second film content and appropriately converts it.
- **Auto2:** Compatible with 30 frame-per-second film content in addition to 24 frame-per-second film content. (Picture distortion may occur depending on the content)
- **Video:** Select when using "Auto1" and "Auto2", and the video content is distorted.

## Audio menu—Change the sound effect

### V.S.S. **HDD** **RAM** **DVD-R** **DVD-V**

(Dolby Digital, 2-channel or over only)

Enjoy a surround-like effect if you are using two front speakers only.

- Turn V.S.S. off if it causes distortion.
- V.S.S. does not work for SAP recordings.

### Dialog Enhancer **DVD-A** **DVD-V**

(Dolby Digital, 3-channel or over only, including a center channel)

The volume of the center channel is raised to make dialog easier to hear.

## Status messages

Status messages appear on the television during operation to show the condition of the unit.

### Press [STATUS].

The display changes each time you press the button.

- Displayed information are examples.

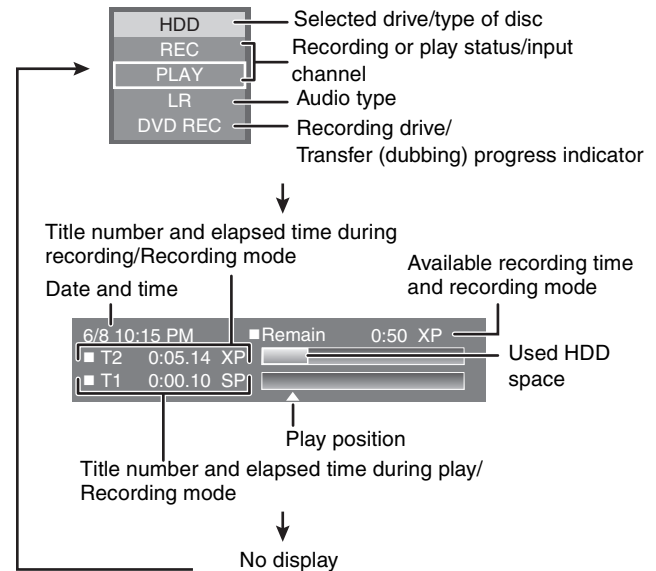

\* Only when you have selected "480P" in "TV Type" (⇒ page 12).

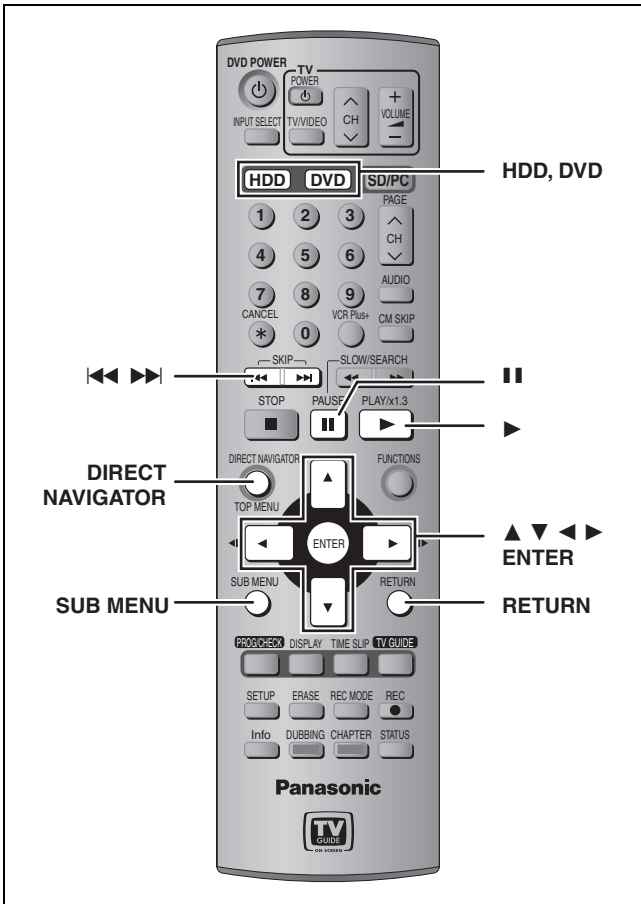

## Editing titles/chapters and playing chapters

### Preparation

- Press [HDD] or [DVD] to select the drive.
- Release protection (⇒ page 44). **RAM**

- 1 Press [DIRECT NAVIGATOR].
- 2 **HDD RAM**  
Press [▲, ▼, ◀, ▶] to select “VIDEO” tab and press [ENTER].
- 3 Press [▲, ▼, ◀, ▶] to select the title.

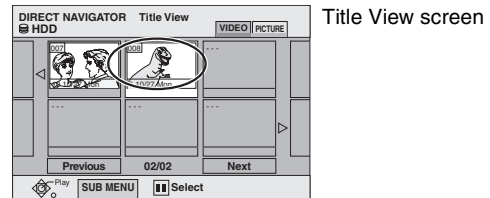

### To show other pages

Press [▲, ▼, ◀, ▶] to select “Previous” or “Next” and press [ENTER].

- You can also press [◀◀, ▶▶] to show other pages.

### Multiple editing

Select with [▲, ▼, ◀, ▶] and press [■]. (Repeat.)  
A check mark appears. Press [■] again to cancel.

- 4 Press [SUB MENU], then [▲, ▼] to select the operation and press [ENTER].
- If you select “Edit”, press [▲, ▼] to select the operation and press [ENTER].

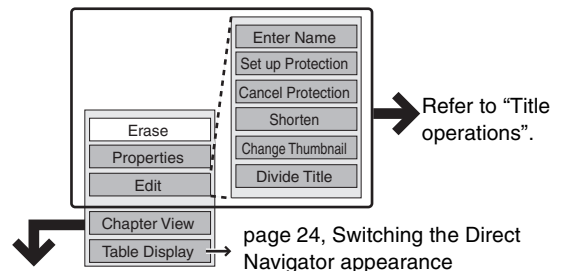

If you select “Chapter View”

- 5 Press [▲, ▼, ◀, ▶] to select the chapter.
- To start play ⇒ Press [ENTER].  
To edit ⇒ Step 6.

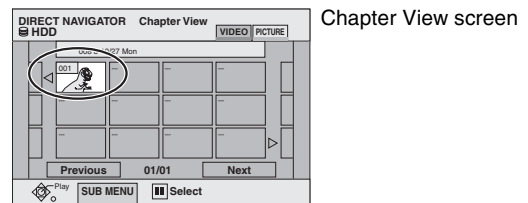

- 6 Press [SUB MENU], then [▲, ▼] to select the operation and press [ENTER].

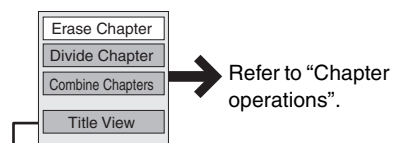

### To exit the screen

Press [DIRECT NAVIGATOR].

### To return to the previous screen

Press [RETURN].

### HDD RAM DVD-R

#### Title/Chapter

Programs are recorded as a single title consisting of one chapter.

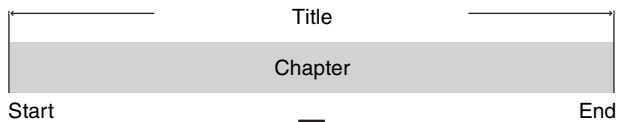

You can divide a title into multiple chapters. **HDD RAM**  
(⇒ page 26, Create chapters, ⇒ page 33, Divide Chapter)



You can change the order of chapters and create a play list  
(⇒ page 34). **HDD RAM**

- Titles are divided into about 5-minute chapters after finalizing (⇒ page 45). **DVD-R**

- The maximum number of items on a disc

#### HDD

- Titles: 500
- Chapters: Approximately 1000 per title (Depends on the state of recording.)

#### RAM DVD-R

- Titles: 99
- Chapters: Approximately 1000 (Depends on the state of recording.)

#### Note

- Once erased, divided or shortened, it cannot be restored to its original state. Make certain before proceeding.
- You cannot edit during recording, chasing play or transferring (dubbing), etc.
- Restricted recording information remains even after editing (e.g. dividing a title, etc).

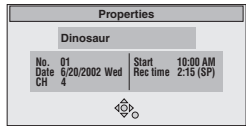
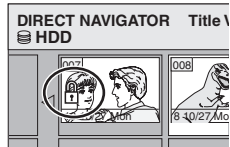
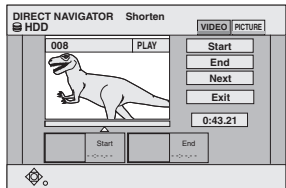
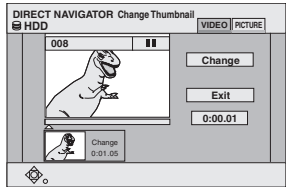
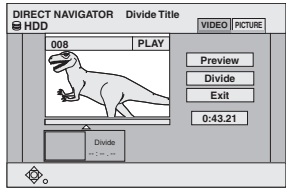

## Title operations

<b>Erase*</b> <b>HDD RAM DVD-R</b>	<p><b>Press [◀, ▶] to select “Erase” and press [ENTER].</b></p> <ul style="list-style-type: none"> <li>•Once erased, the recorded contents are lost and cannot be restored. Make certain before proceeding.</li> <li>•The available recording time on DVD-R does not increase when you erase titles.</li> </ul>
<b>Properties</b> <b>HDD RAM DVD-R</b>	<p>Information (e.g., time and date) is shown.</p> 
<b>Enter Name</b> <b>HDD RAM DVD-R</b>	<p>You can give names to recorded titles.          ➔ page 46, Entering text</p>
<b>Set up Protection*</b> <b>Cancel Protection*</b> <b>HDD RAM</b>	<p>If set, this will protect the title from accidental erasure.</p> <p><b>Press [◀, ▶] to select “Yes” and press [ENTER].</b></p> <p>The lock symbol appears when the title is protected.</p> 
<b>Shorten</b> <b>HDD RAM</b>	<p>You can remove unnecessary parts of the recording such as commercials.</p> <ol style="list-style-type: none"> <li>① Press [ENTER] at the start point and end point of the section you want to erase.</li> <li>② Press [▲, ▼] to select “Exit” and press [ENTER].             <ul style="list-style-type: none"> <li>•Select “Next” and press [ENTER] to erase other sections.</li> </ul> </li> <li>③ Press [◀, ▶] to select “Erase” and press [ENTER].</li> </ol> 
<b>Change Thumbnail</b> <b>HDD RAM DVD-R</b>	<p>You can change the image to be shown as the thumbnail picture in the Title View.</p> <ol style="list-style-type: none"> <li>① Press [▶] (PLAY) to start play.</li> <li>② Press [ENTER] when the image you want to use as a thumbnail is shown.</li> <li>③ Press [▲, ▼] to select “Exit” and press [ENTER].</li> </ol> 
<b>Divide Title</b> <b>HDD RAM</b>	<p>You can divide a title into two.</p> <ol style="list-style-type: none"> <li>① Press [ENTER] at the point you want to divide the title.</li> <li>② Press [▲, ▼] to select “Exit” and press [ENTER].</li> <li>③ Press [◀, ▶] to select “Divide” and press [ENTER].</li> </ol> <p><b>To confirm the division point</b>          Press [▲, ▼] to select “Preview” and press [ENTER]. (The unit plays 10 seconds before and after the division point.)</p> <p><b>To change the division point</b>          Restart play and press [▲, ▼] to select “Divide”, then press [ENTER] at the point you want to change.</p> <p><b>Note</b></p> <ul style="list-style-type: none"> <li>•The divided titles retain the name and CPRM property (➔ page 53) of the original title.</li> <li>•Video and audio just before and after the dividing point may momentarily cut out.</li> </ul> 

\* Multiple editing is possible.

## Chapter operations

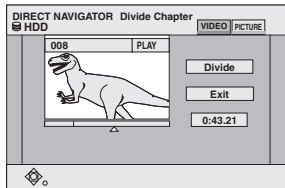
<b>Erase Chapter*</b> <b>HDD RAM</b>	<p><b>Press [◀, ▶] to select “Erase” and press [ENTER].</b></p> <ul style="list-style-type: none"> <li>•Once erased, the recorded contents are lost and cannot be restored. Make certain before proceeding.</li> </ul>
<b>Divide Chapter</b> <b>HDD RAM</b>	<ol style="list-style-type: none"> <li>① Press [ENTER] at the point you want to divide.             <ul style="list-style-type: none"> <li>•Repeat this step to divide at other points.</li> </ul> </li> <li>② Press [▲, ▼] to select “Exit” and press [ENTER].</li> </ol> 
<b>Combine Chapters</b> <b>HDD RAM</b>	<p><b>Press [◀, ▶] to select “Combine” and press [ENTER].</b></p> <ul style="list-style-type: none"> <li>•The selected chapter and next chapter are combined.</li> </ul>

\* Multiple editing is possible.

### For quicker editing

- Use search, Time Slip or slow-motion (➔ page 25) to find the desired point.
- Press [|◀◀, ▶▶|] to skip to the end of a title.

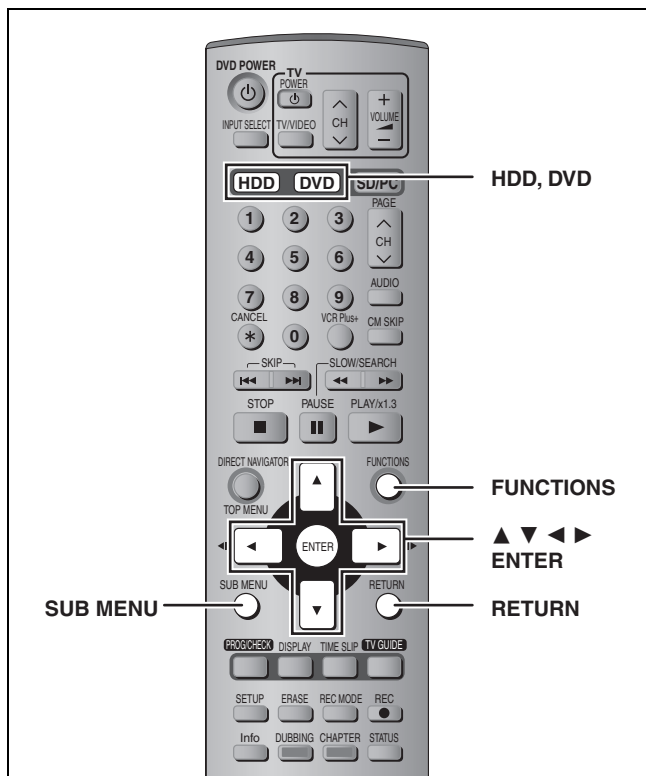

**HDD | RAM**

You can arrange the chapters (→ page 32) to create a play list.

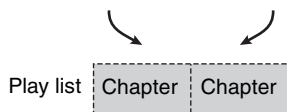
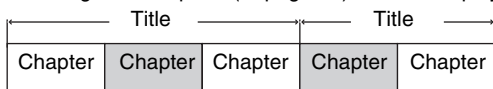

Transferring (dubbing) (→ page 37) a play list will create a title.

- Play lists are not recorded separately so this doesn't use much capacity.
- Editing play lists doesn't modify the recorded data.

- The maximum number of items on a disc
  - Play lists: 99
  - Chapters in play lists: Approximately 1000 (Depends on the state of recording.)

**Note**

You cannot create or edit a play list while recording or while transferring (dubbing).

## Creating play lists

**Preparation**

- Press [HDD] or [DVD] to select the drive.
- Release protection (→ page 44). **RAM**

- 1 While stopped**  
Press [FUNCTIONS].



- 2** Press [▲, ▼, ◀, ▶] to select “PLAY LIST” and press [ENTER].



- 3** Press [▲, ▼, ◀, ▶] to select “Create” and press [ENTER].

- 4** Press [◀, ▶] to select the source title and press [▼].

- Press [ENTER] to select all the chapters in the title, then skip to step 6.

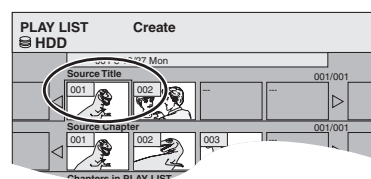

- 5** Press [◀, ▶] to select the chapter you want to add to a play list and press [ENTER].

Press [▲] to cancel.

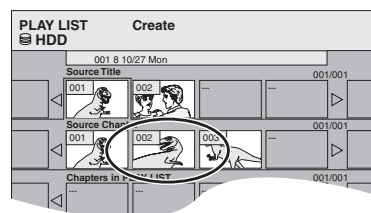

- You can also create a new chapter from the source title. Press [SUB MENU] to select “Divide Chapter” and press [ENTER] (→ page 33, Divide Chapter).

- 6** Press [◀, ▶] to select the position to insert the chapter and press [ENTER].

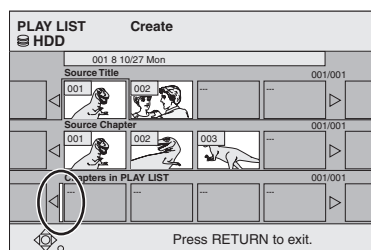

- Press [▲] to select other source titles.
- Repeat steps 5–6 to add other chapters.

- 7** Press [RETURN].

**To exit the screen**

Press [RETURN] several times.

**To return to the previous screen**

Press [RETURN].

## Editing and playing play lists/chapters

- 1 Press [FUNCTIONS].
- 2 Press [▲, ▼, ◀, ▶] to select “PLAY LIST” and press [ENTER].
- 3 Press [▲, ▼, ◀, ▶] to select the play list.

To start play → Press [ENTER].  
To edit → Step 4.

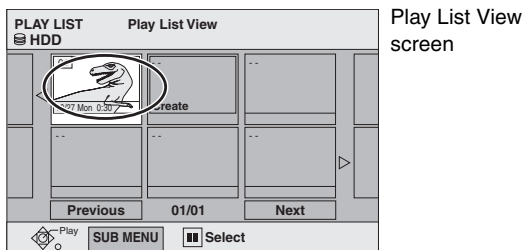

Play List View screen

•To show other pages/Multiple editing (⇒ page 32)

- 4 Press [SUB MENU], then [▲, ▼] to select the operation and press [ENTER].

•If you select “Edit”, press [▲, ▼] to select the operation and press [ENTER].

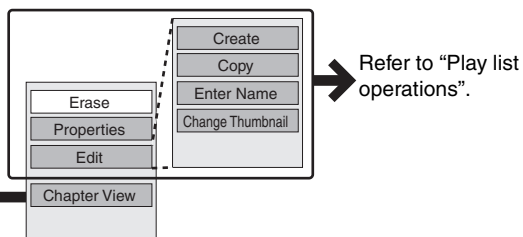

If you select “Chapter View”

- 5 Press [▲, ▼, ◀, ▶] to select the chapter.

To start play → Press [ENTER].  
To edit → Step 6.

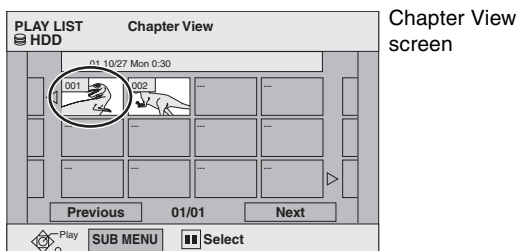

Chapter View screen

•To show other pages/Multiple editing (⇒ page 32)

- 6 Press [SUB MENU], then [▲, ▼] to select the operation and press [ENTER].

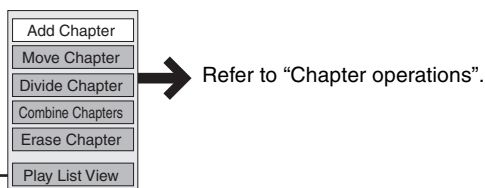

•You can go back to the Play List View.

### To exit the screen

Press [RETURN] several times.

### To return to the previous screen

Press [RETURN].

## Play list operations

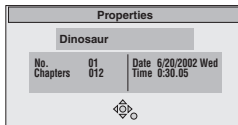
Erase*	Press [◀, ▶] to select “Erase” and press [ENTER].
Properties	Play list information (e.g., time and date) is shown. 
Create	⇒ page 34, Creating play lists, Step 4–7
Copy*	Press [◀, ▶] to select “Copy” and press [ENTER].
Enter Name	⇒ page 46, Entering text
Change Thumbnail	⇒ page 33, Change Thumbnail

\* Multiple editing is possible.

## Chapter operations

Editing chapters in a play list does not modify the source titles and source chapters.

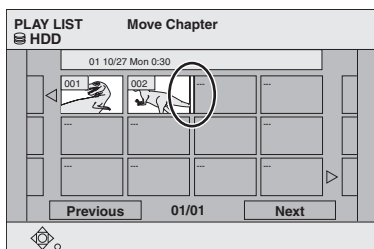
Add Chapter	⇒ page 34, Creating play lists, Step 4–6
Move Chapter	Press [▲, ▼, ◀, ▶] to select the position to insert the chapter and press [ENTER]. 
Divide Chapter	⇒ page 33, Divide Chapter
Combine Chapters	⇒ page 33, Combine Chapters
Erase Chapter*	⇒ page 33, Erase Chapter

\* Multiple editing is possible.

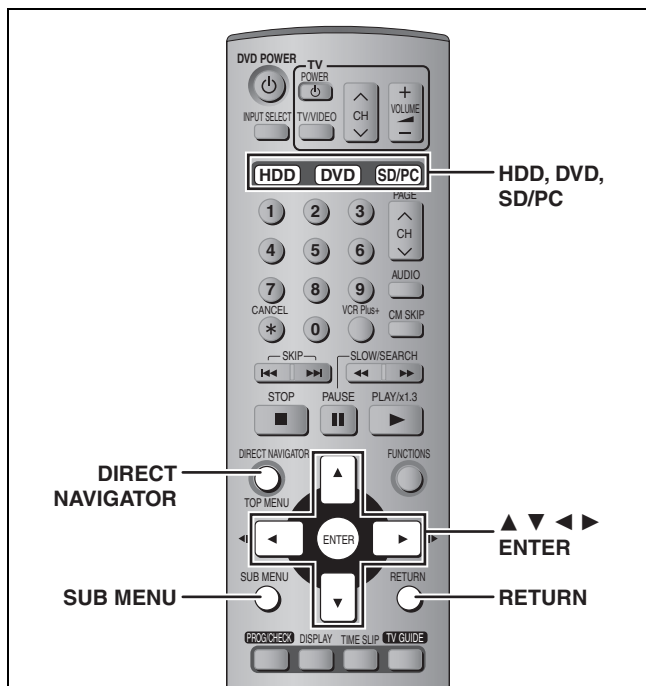

## HDD RAM SD PC

### Preparation

- Press [HDD], [DVD] or [SD/PC] to select the drive.
- Release protection (⇒ page 44).

- 1 Press [DIRECT NAVIGATOR].
- 2 **HDD RAM**  
Press [▲, ▼, ◀, ▶] to select “PICTURE” tab and press [ENTER].
- 3 Press [▲, ▼, ◀, ▶] to select the still picture.  
  - To show other pages/Multiple editing (⇒ page 32)
  - To select the still pictures in another folder (⇒ page 29)
- 4 Press [SUB MENU], then [▲, ▼] to select the operation and press [ENTER].

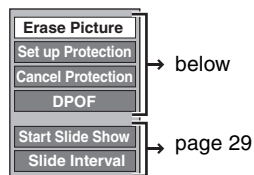

### To edit still picture folders

In step 3 (⇒ above)

- ① Press [▲, ▼, ◀, ▶] to select “Folder” and press [ENTER].
- ② Press [▲, ▼] to select the folder.  
  - To show other pages/Multiple editing (⇒ page 32)
- ③ Press [SUB MENU], then [▲, ▼] to select the operation and press [ENTER].  
  - To select another higher folder (⇒ page 29)

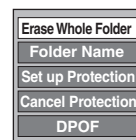

### To exit the screen

Press [DIRECT NAVIGATOR].

### To return to the previous screen

Press [RETURN].

## Picture and folder operation

### Erase Picture\*

### Erase Whole Folder\*

HDD RAM SD PC

### Press [◀, ▶] to select “Erase” and press [ENTER].

- Once erased, the recorded contents are lost and cannot be restored. Make certain before proceeding.
- When erasing a folder, even the files not containing still pictures will also be erased if they are inside the folder. (This does not apply to folders under the folder concerned.)

### Set up Protection\*

### Cancel Protection\*

HDD RAM SD PC

If set, this will protect the still picture or folder from accidental erasure.

### Press [◀, ▶] to select “Yes” and press [ENTER].

- The lock symbol appears when the still picture or folder is protected.
- Even if the protection setting is used by this unit to protect a folder, the folder may be erased by another unit.

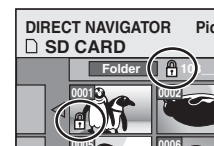

### DPOF\*

SD PC

You can select a whole folder or individual pictures for printing and specify the number of prints to be made.

### Press [◀, ▶] to select number of print (0 to 9) and press [ENTER].

The DPOF mark appears.

- This appears on the still pictures inside a folder when you make the DPOF setting for the folder.

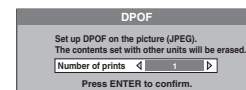

### To cancel the print setting

Set the number of print to “0”.

- When this is set by this unit, any settings established by other units will be released.
- Print settings (DPOF) made using this unit may not be viewable on other equipment.
- Settings cannot be made for folders and files not in accordance with DCF standards or if there is no remaining space on the card.

### Folder Name

HDD RAM SD PC

You can give names to still picture folders.

⇒ page 46, Entering text

- Folder names input using this unit may not be displayed on other equipment.

\* Multiple editing is possible.

# Transferring (dubbing) titles or play lists

**HDD RAM DVD-R**

You can select from a variety of methods to transfer (dub) on this unit.

## ■ Transferring (dubbing) direction

You can transfer (dub) your favorite titles and play lists to an archive disc. ● Transferring (dubbing) a play list will create a title.		When you want to re-edit finalized content on a DVD-R, etc.
● When you want to play a transferred (dubbed) disc on other equipment, you must finalize the disc after transferring (dubbing) (⇒ page 45, 53). *Before recording to HDD, set “DVD-R High-Speed Recording” to “On” (⇒ page 48).		*Finalized DVD-R or DVD-Video on sale that is not copy-protected, etc.

**Normal speed mode:** Select XP, SP, LP, EP or FR as the recording mode for transferring (dubbing) (⇒ page 17).

## ■ Transferring (dubbing) mode

Transferring (dubbing) a title or a play list	Transferring (dubbing) multiple titles and play lists together
↓	↓
One Touch Transfer (dubbing) (⇒ page 38)	Transferring (dubbing) using the transferring (dubbing) list (⇒ page 38)
	↓
You can select transferring (dubbing) speed mode and picture quality (⇒ below)	

## ■ Transferring (dubbing) speed mode types and features

	High speed	Normal speed (XP, SP, LP, EP, FR)
<b>Features</b>	You can transfer (dub) in a very short amount of time. You can transfer (dub) even faster if you use a high speed recording compatible disc. You can record and play using the HDD while high speed transferring (dubbing).	You can record for a long period of time on 1 disc. For example, using LP mode, you can record approximately 4 hours on 1 (4.7 GB) disc (⇒ page 17). e.g., 1 hour TV drama 
<b>Transferring (dubbing) times</b>	⇒ below, Approximate transferring (dubbing) times	The same amount of time it takes to record the source
<b>Picture quality</b>	Original picture quality	Can change*
<b>Are chapters/thumbnails maintained?</b>	Yes	No (One title is recorded as one chapter. Thumbnails return to the default position.)
<b>Other operations while transferring (dubbing)</b>	You can record/play using the HDD.	No

\*If you select a recording mode with better picture quality than the original, the picture quality does not improve. (However, it does prevent against degradation of picture quality.)

## ■ Approximate transferring (dubbing) times (Max. speed)

(excludes time required to write data management information)

HDD		3x high speed recording compatible DVD-RAM		4x high speed recording compatible DVD-R	
Recording mode	Recording time	Required time	Speed	Required time	Speed
XP	1 hour	Approx. 20 min.	3x	Approx. 15 min.	4x
SP		Approx. 10 min.	6x	Approx. 7.5 min.	8x
LP		Approx. 5 min.	12x	Approx. 4 min.	16x
EP (6H)		Approx. 3.5 min.	18x	Approx. 2.5 min.	24x
EP (8H)		Approx. 2.5 min.	24x	Approx. 2 min.	32x

### Note

- When recording or playing while transferring (dubbing), the unit may not use the maximum recording speed.
- Depending on the condition of the disc, the unit may not transfer (dub) using the maximum speed.

## Regarding high speed transfer (dubbing) to DVD-R

To high speed transfer (dub) titles (or play lists created from those titles), set “DVD-R High-Speed Recording” to “On” before recording to the HDD (⇒ page 48).

However, in the following cases, transferring (dubbing) to DVD-R using the high speed mode does not work.

- Play lists created from titles using a variety of recording modes
- Play lists created from multiple titles using FR recording mode
- Play lists mixed with a variety of audio types (Dolby Digital and LPCM, etc.)
- Titles that contain many erased segments.

## Regarding transferring (dubbing) of digital broadcasts that allow “One time only recording”

You can transfer (dub) a recorded title to a CPRM (⇒ page 53) compatible DVD-RAM; however, the title is erased from the HDD.

- You cannot use one touch transfer (dubbing). Use the transferring (dubbing) list (⇒ page 38).
- Titles will not be transferred (dubbed) if they are protected (⇒ page 33).
- You cannot transfer (dub) play lists created from “One time only recording” titles.
- Titles with recording limitations and play lists cannot be registered on the same transferring (dubbing) list.
- Titles or play lists cannot be transferred (dubbed) from DVD-RAM to the HDD.

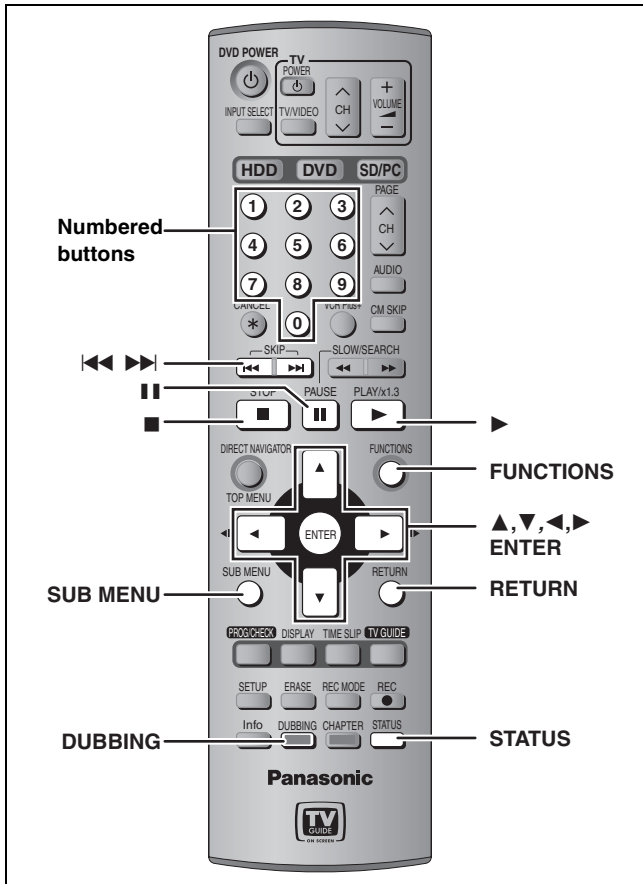

### One Touch Transfer (dubbing)

HDD → RAM  
HDD → DVD-R

**Preparation**

Select the audio type for recording MTS broadcasts from “Select MTS” (⇒ page 48) when transferring (dubbing) to a DVD-R.

- 1 Play the title or play list you want to transfer (dub).
- 2 Press [DUBBING].

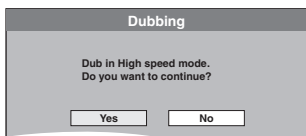

- 3 Press [◀, ▶] to select “Yes” and press [ENTER].

•The transfer (dubbing) speed and picture quality are set as follows.

The recording mode changes to FR mode if the remaining disc space is exceeded using one of the recording modes indicated below.

HDD → RAM: High speed mode  
HDD → DVD-R:

DVD-R High-Speed Recording setting	
On	Off
High speed mode	Same recording mode used as when recording the source title (XP-EP, FR). •Play lists are transferred (dubbed) in FR mode.

**Note**

Titles and play lists cannot be transferred (dubbed) if they contain a broadcast that allows “One time only recording”.

### Transferring (dubbing) using the transferring (dubbing) list

HDD ↔ RAM  
HDD → DVD-R

You can order titles and play lists for transfer (dubbing) as desired as well as select the speed and picture quality.

**Preparation**

Select the audio type for recording MTS broadcasts from “Select MTS” (⇒ page 48) when:

- Transferring (dubbing) to a DVD-R.
- When “Audio for XP Recording” is set to “LPCM” (⇒ page 49) and you are transferring (dubbing) in XP mode.

- 1 While stopped Press [FUNCTIONS].
- 2 Press [▲, ▼, ◀, ▶] to select “DUBBING” and press [ENTER].

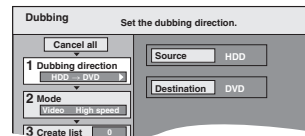

- If you are not going to change the registered list press [▼] several times (⇒ step 7).

- 3 Press [▲, ▼] to select “Dubbing direction” and press [▶].

- ① Press [▲, ▼] to select “Source” and press [ENTER].
- ② Press [▲, ▼] to select the drive and press [ENTER].
- ③ Press [▲, ▼] to select “Destination” and press [ENTER].

The same drive as the transfer (dubbing) source cannot be selected.

- ④ Press [▲, ▼] to select the drive and press [ENTER].
- ⑤ Press [◀] to confirm.

- 4 Press [▲, ▼] to select “Mode” and press [▶].

- ① Press [▲, ▼] to select “Format” and press [ENTER].
- ② Press [▲, ▼] to select “Video” and press [ENTER].
- ③ Press [▲, ▼] to select “Recording mode” and press [ENTER].
- ④ Press [▲, ▼] to select the mode and press [ENTER].
- ⑤ Press [◀] to confirm.

- 5 Press [▲, ▼] to select “Create list” and press [▶].

Select the transferring (dubbing) items and register on the list.

- When transferring (dubbing) to DVD-R using high speed mode, only items indicated with “▶▶▶” can be registered.

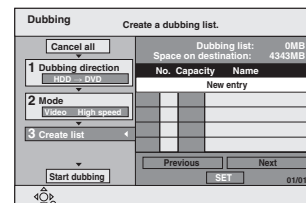

- ① Press [▲, ▼] to select “New entry” and press [ENTER].
- ② Press [▲, ▼, ◀, ▶] to select “Video” or “Play List” tab and press [ENTER].

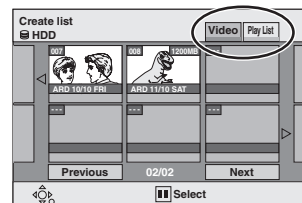

③ Press [**▲**, **▼**, **◀**, **▶**] to select the titles or play lists and press [ENTER].

• To select a multiple number of items together, press [**■**] to add the check mark and press [ENTER] (⇒ below, Multiple editing).

• To show other pages (⇒ below)

• To edit the transferring (dubbing) list (⇒ below)

## 6 Press [**▲**, **▼**] to select “SET” and press [ENTER].

The transferring (dubbing) list is registered.

## 7 Press [**▲**, **▼**] to select “Start dubbing” and press [ENTER].

Press [**◀**, **▶**] to select “Yes” and press [ENTER] to start transferring (dubbing).

### ■ To edit the transferring (dubbing) list

Select the item in step 5 (⇒ page 38, right column)

1 Press [SUB MENU].

2 Press [**▲**, **▼**] to select the operation and press [ENTER].

\* Multiple editing is possible (⇒ below).



### To cancel all registered transferring (dubbing) setting and lists

In step 3 (⇒ page 38, right column)

1 Press [**▲**, **▼**] to select “Cancel all” and press [ENTER].

2 Press [**◀**, **▶**] to select “Yes” and press [ENTER].

• The settings and lists may be cancelled in the following situations.

– When a title, still picture, etc. has been recorded or erased at the transfer (dubbing) source

– When steps have been taken, for instance, to turn off the unit, open the tray, change the transfer (dubbing) direction, etc.

#### To show other pages

Press [**▲**, **▼**, **◀**, **▶**] to select “Previous” or “Next” and press [ENTER].

• You can also press [**◀◀**, **▶▶**] to show other pages.

#### Multiple editing

Select with [**▲**, **▼**, **◀**, **▶**] and press [**■**]. (Repeat.)

Press [ENTER] to register to the list.

• A check mark appears. Press [**■**] again to cancel.

• When you switch between the “Video” and “Play List” tab, the check mark is cancelled.

### Transferring (dubbing) list icons



Titles and play lists that can be transferred (dubbed) in high speed mode to DVD-R (⇒ page 48)



Title with “One time only recording” restriction



Titles erased from the HDD by “One time only recording” restriction after transferring (dubbing).



Title or play list contains still picture(s)  
• Still picture(s) cannot be transferred (dubbed).

### Data size of each registered item

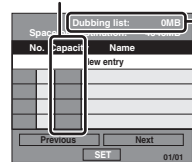

Data size recorded to the transfer (dubbing) destination

• For normal speed transfer (dubbing), the total data size changes according to the recording mode.

• When transferring (dubbing) to the HDD using high speed mode, data management information is automatically added so the total data size becomes larger than the sum of the data size for all registered items.

### ■ To stop transferring (dubbing)

Press and hold [RETURN] for 3 seconds.

• If stopped partway, transferring (dubbing) will be up to that point. However, in high speed mode, only titles that have completed transferring (dubbing) at the point stopped are transferred (dubbed). [Even if the title was not transferred (dubbed) to the DVD-R, the amount of remaining writable disc space becomes less.]

### ■ To return to the previous screen

Press [RETURN].

### ■ Recording and playing while transferring (dubbing)

You can record and play using the HDD while high speed transferring (dubbing).

Press [ENTER] to cancel the screen display.

#### • To confirm the current progress

Press [STATUS].

#### Note

- You cannot perform chasing play or edit, etc. while transferring (dubbing).
- Timer recordings executed while transferring (dubbing) are recorded to the HDD regardless of the recording drive settings.
- You cannot play a play list while transferring (dubbing) titles with “One time only recording” restriction (⇒ page 37).

Refer to the control reference on page 38.

## Transferring (dubbing) a finalized DVD-R

DVD-V → HDD

While playing a disc, the content being played is transferred (dubbed) to the HDD according to the set time.



- Operations and on screen displays during transfer (dubbing) are also recorded.
- Almost all DVD-Video on sale have been treated to prevent illegal copying, and cannot be transferred (dubbed).
- The following cannot be transferred (dubbed): DVD-Audio, Video CD, Audio CD and so on.

After performing steps 1–4 (“Format” is automatically set to “DVD-Video”.) (➔ page 38, right column)

**5 Press [▲, ▼] to select “Time to end” and press [▶].**

**6 Press [◀, ▶] to select “Hour” and “Min.” and press [▲, ▼] to set the recording time.**

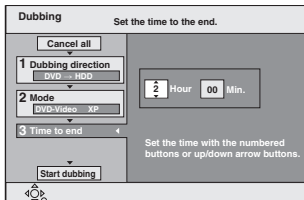

- You can also set the recording time with the numbered buttons.
- Set a few minutes longer than the source title, in order to include the operation time before play begins.

**7 Press [◀] to select “Time to end”.**

**8 Press [▲, ▼] to select “Start dubbing” and press [ENTER].**

Press [◀, ▶] to select “Yes” and press [ENTER] to start transferring (dubbing).

The disc top menu is displayed.

- Disc play automatically begins from title 1 when “Title 1” is selected from the “Select First play” menu when finalizing the disc (➔ page 45).

**9 When the top menu is displayed Press [▲, ▼, ▶, ▶] to select the title you want to start transferring (dubbing), and press [ENTER].**

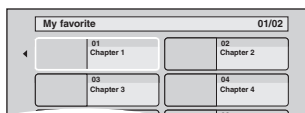

While playing in order, all the titles after the selected title are recorded until the set time. (After the last title on the disc has finished playing the top menu is recorded until the set time is reached.)

### Note

- The screen on the right (screen saver) is recorded at the beginning.
- Recorded as 1 title from the start of transfer (dubbing) to the end.
- If play does not begin automatically or if the top menu does not display automatically, press [▶] (PLAY) to start.
- Even if you transfer (dub) a high quality video/audio DVD, the original picture and audio quality cannot be exactly replicated.

### To stop transferring (dubbing)

Press [■].

You can also press and hold [RETURN] for 3 seconds to stop transferring (dubbing).

- If stopped partway, transferring (dubbing) will be up to that point.

### To return to the previous screen

Press [RETURN].



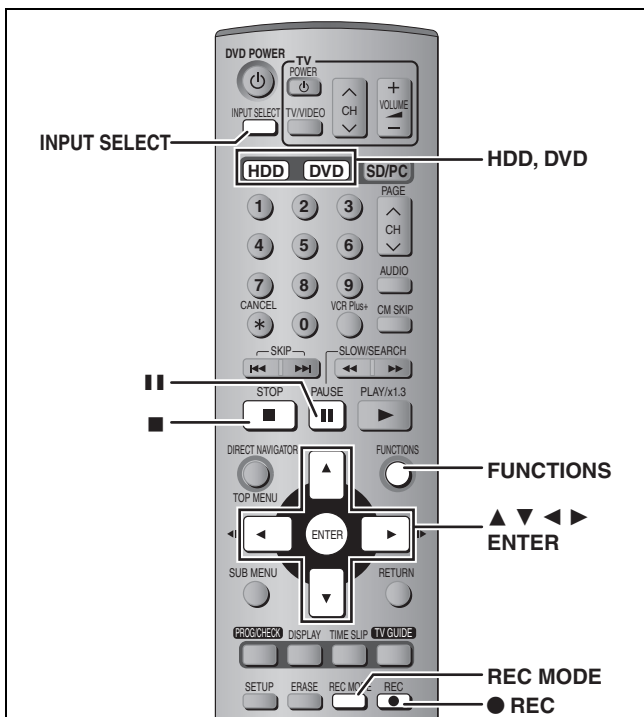

e.g.: Connecting other video equipment to the L2 or DV input terminals

- Turn off the unit and other video equipment before connecting.

This unit

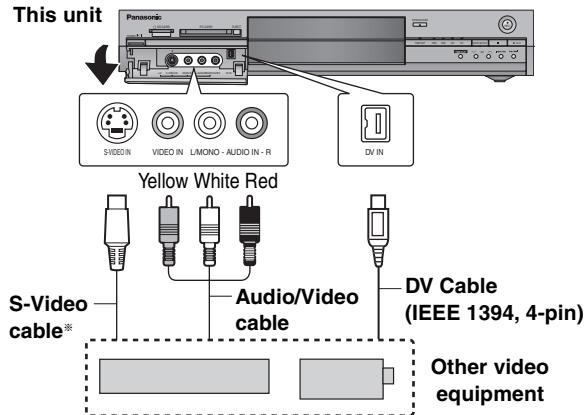

If the audio output of the other equipment is monaural, connect to L/MONO.

\* The S-VIDEO terminal achieves a more vivid picture than the VIDEO terminal.

### When recording from the unit's DV terminal

Select the type of audio recording from "Select Audio CH for DV Input" in the SETUP menu (➔ page 49).

## Manual recording

**HDD** **RAM** **DVD-R**

### Preparation

- Connect a video cassette recorder to this unit's input terminals.
- Press [HDD] or [DVD] to select the recording drive.

### Note

When recording using this unit's input terminals, only the sound received at the time of recording will be recorded. As long as secondary audio that is recorded on the video cassette is not output on the unit in play, it is not recorded.

- 1 While stopped

Press [INPUT SELECT] to select the input channel for the equipment you have connected.

e.g., If you have connected to L2 input terminals, select "L2".

- 2 Press [REC MODE] to select the recording mode.

- 3 Start play on the other equipment.

- 4 Press [● REC].

Recording starts.

### To skip unwanted parts

Press [II] to pause recording. (Press again to restart recording.)

### To stop recording

Press [■].

### To record programs to fill up the remaining space on the disc

➔ page 18, Flexible Recording

Almost all videos and DVD software on sale have been treated to prevent illegal copying. Any software that has been so treated cannot be recorded using this unit.

## DV automatic recording (DV AUTO REC)

**HDD** **RAM**

When the "DV AUTO REC" function is used, programs are recorded as a title while at the same time chapters are created at each break in the images and the play list is created automatically.

### Preparation

- 1 Turn off the main unit and DV equipment, then connect the equipment with the unit's DV input terminal (➔ left).
- 2 Turn on the main unit and DV equipment.
- 3 Pause play of the DV equipment at the point you want recording to start.
- 4 Press [HDD] or [DVD] to select the recording drive.

- 1 While stopped

Press [FUNCTIONS].

- 2 Press [▲, ▼, ◀, ▶] to select "DV AUTO REC" and press [ENTER].

- 3 Press [REC MODE] to select the recording mode.

- 4 Press [◀, ▶] to select "Rec" and press [ENTER].

Recording starts.

### When recording finishes

The confirmation screen appears. Press [ENTER] to finish DV automatic recording.

### To stop recording

Press [■].

### Note

- Only one piece of DV equipment (e.g., digital video camcorder) can be connected to the unit via the DV input terminal.
- It is not possible to operate the unit from the connected DV equipment.
- The DV input on this unit is for use with DV equipment only. (It cannot be connected to a computer, etc.)
- The DV equipment name may not be shown correctly.
- Depending on the DV equipment, the images or audio may not be input properly.
- The date and time information on the tape of the DV equipment will not be recorded.
- You cannot record and play simultaneously.

If the DV automatic recording function does not work properly, check the connections and DV equipment settings, and turn the unit off and back on.

If that does not work, follow the instructions for manual recording (➔ left).

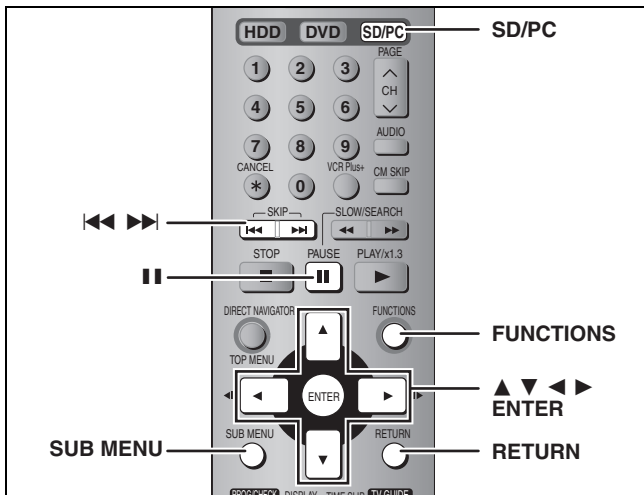

HDD | RAM | SD | PC

## Transferring (dubbing) using the transferring (dubbing) list

- 1 While stopped  
Press [FUNCTIONS].
- 2 Press [▲, ▼, ◀, ▶] to select "DUBBING" and press [ENTER].

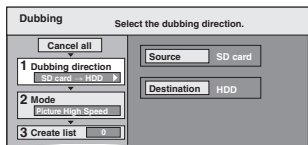

If you are not going to change the registered list press [▼] several times (⇒ step 7).

- 3 Press [▲, ▼] to select "Dubbing direction" and press [▶].
  - 1 Press [▲, ▼] to select "Source" and press [ENTER].
  - 2 Press [▲, ▼] to select the drive and press [ENTER].
  - 3 Press [▲, ▼] to select "Destination" and press [ENTER].
  - 4 Press [▲, ▼] to select the drive and press [ENTER].  
The same drive as the transfer (dubbing) source can be selected.
  - 5 Press [◀] to confirm.
- 4 Press [▲, ▼] to select "Mode" and press [▶].
  - 1 Press [▲, ▼] to select "Format" and press [ENTER].
  - 2 Press [▲, ▼] to select "Picture" and press [ENTER].  
"Recording mode" is automatically set to "High speed".
  - 3 Press [◀] to confirm.

- 5 Press [▲, ▼] to select "Create list" and press [▶].  
Select the transferring (dubbing) items and register on the list. Still pictures and folders cannot be registered on the same list.

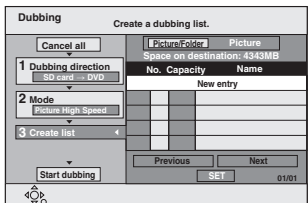

- To register individual still pictures
  - 1 Press [▲, ▼] to select "New entry" and press [ENTER].
  - 2 Press [▲, ▼, ◀, ▶] to select a still picture and press [ENTER].
  - To select a multiple number of items together, press [■] to add the check mark and press [ENTER] (⇒ right, Multiple editing).
  - To show other pages (⇒ right)
  - To select the still pictures in another folder (⇒ right)
  - To edit the transferring (dubbing) list (⇒ right)

### ■ To register on a folder by folder basis

- 1 Press [▲, ▼] to select "Picture/Folder" and press [ENTER].

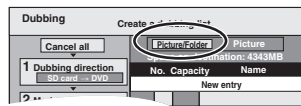

- 2 Press [▲, ▼] to select "Folder" and press [ENTER].
  - 3 Press [▲, ▼] to select "New entry" and press [ENTER].
  - 4 Press [▲, ▼] to select the folder and press [ENTER].
- To select a multiple number of items together, press [■] to add the check mark and press [ENTER] (⇒ below, Multiple editing).
  - To show other pages (⇒ below)
  - To switch another higher folder (⇒ below)
  - To edit the transferring (dubbing) list (⇒ below)

- 6 Press [▲, ▼] to select "SET" and press [ENTER].  
The transferring (dubbing) list is registered.

- 7 Press [▲, ▼] to select "Start dubbing" and press [ENTER].

- For individual still pictures only  
When specifying another folder as the transferring (dubbing) destination, select "Folder".

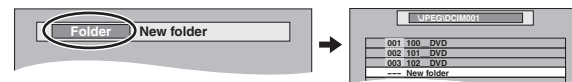

Press [◀, ▶] to select "Yes" and press [ENTER] to start transferring (dubbing).

### To stop transferring (dubbing)

Press and hold [RETURN] for 3 seconds.

### To return to the previous screen

Press [RETURN].

### ■ To select another folder

- 1 Press [▲, ▼, ◀, ▶] to select "Folder" and press [ENTER].
- 2 Press [▲, ▼] to select the folder and press [ENTER].



- The still pictures of different folders cannot be registered on the same list.
- If there is a multiple number of higher folders recognizable, you can switch them using [◀, ▶]. (Folders whose higher folders are different cannot be registered on the same list.)

### ■ To edit the transferring (dubbing) list

Select the item in step 5 (⇒ left)

- 1 Press [SUB MENU].
- 2 Press [▲, ▼] to select the operation and press [ENTER].



\* Multiple editing is possible (⇒ below).

### To cancel all registered transferring (dubbing) settings and lists

- 1 Press [▲, ▼] to select "Cancel all" and press [ENTER].
  - 2 Press [◀, ▶] to select "Yes" and press [ENTER].
- The settings and lists may be cancelled in the following situations.
    - When a still picture or folder has been recorded or erased at the transfer (dubbing) source
    - When steps have been taken, for instance, to turn off the unit, remove the card, open the tray, change the transfer (dubbing) direction, etc.

### To show other pages

Press [▲, ▼, ◀, ▶] to select "Previous" or "Next" and press [ENTER].

- You can also press [◀◀, ▶▶] to show other pages.

### Multiple editing

Select with [▲, ▼, ◀, ▶] and press [■]. (Repeat.) Press [ENTER] to register to the list.

- A check mark appears. Press [■] again to cancel.

**Transferring (dubbing) all the still pictures on a card—COPY ALL PICTURES**

SD or PC → HDD or RAM

**Preparation**

Press [SD/PC] to select the source drive.

- 1 While stopped  
Press [FUNCTIONS].
- 2 Press [▲, ▼, ◀, ▶] to select “COPY ALL PICTURES” and press [ENTER].

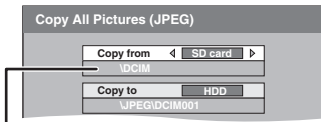

• If there is a multiple number of higher folders recognizable, you can switch them using [◀, ▶].

- 3 Press [▲, ▼] to select “Copy from” and press [◀, ▶] to select the drive.
- 4 Press [▲, ▼] to select “Copy to” and press [◀, ▶] to select the drive.
- 5 Press [▲, ▼, ◀, ▶] to select “Copy” and press [ENTER].

**To stop transferring (dubbing)**

Press and hold [RETURN] for 3 seconds.

**To return to the previous screen**

Press [RETURN].

**Note**

- When transferring (dubbing) the still pictures on a folder by folder or card by card basis, files other than the still picture files inside the folder will also be transferred (dubbed). (This does not apply to the lower folders contained inside the folders.)
- If still pictures are already contained inside the transfer (dubbing) destination folder, the new still pictures are recorded following the existing still pictures.
- If the space on the destination drive runs out or the number of files/folders to be transferred (dubbed) exceeds the maximum (→ page 28), transferring (dubbing) will stop partway through.
- When a name has not been input for the transfer (dubbing) source folder, it is possible that this folder's number will not be the same on the transfer (dubbing) destination. It is recommended that you input a folder name before transferring (dubbing) (→ page 46).
- Print number setting (DPOF) is not transferred (dubbed).
- The sequence in which the still pictures are registered on the transfer (dubbing) list may not be the same at the transfer (dubbing) destination.

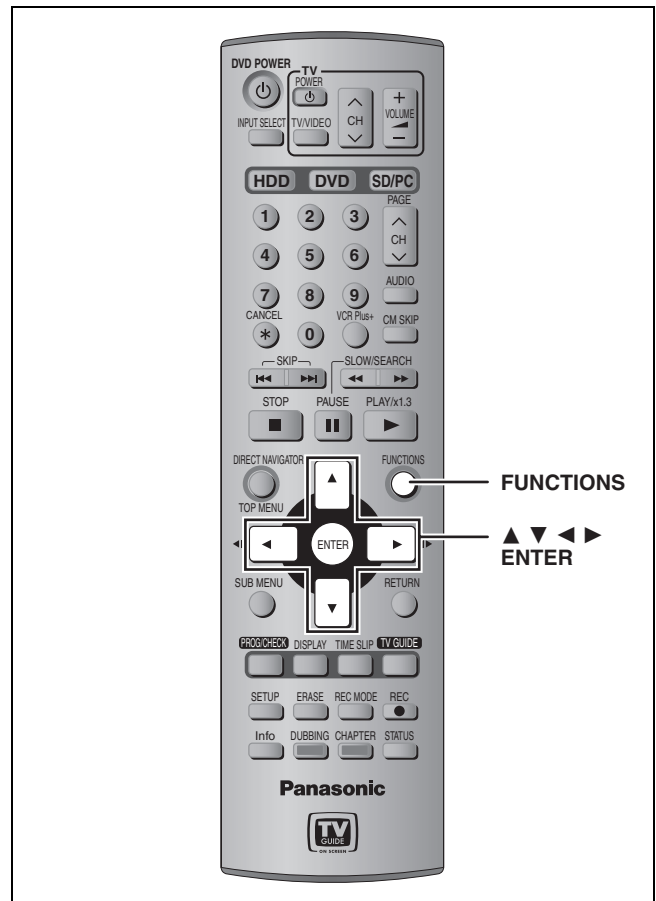

Transfer (Dubbing)

Convenient functions

By using the FUNCTIONS window you may access the main functions quickly and easily.

- 1 While stopped  
Press [FUNCTIONS].

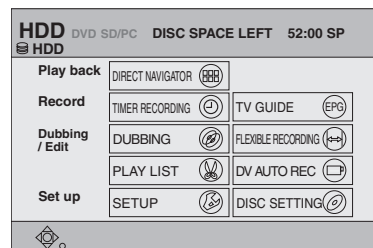

Functions displayed depend on the selected drive or type of disc.

- 2 Press [▲, ▼, ◀, ▶] to select an item and press [ENTER].

**To exit the FUNCTIONS window**

Press [FUNCTIONS].

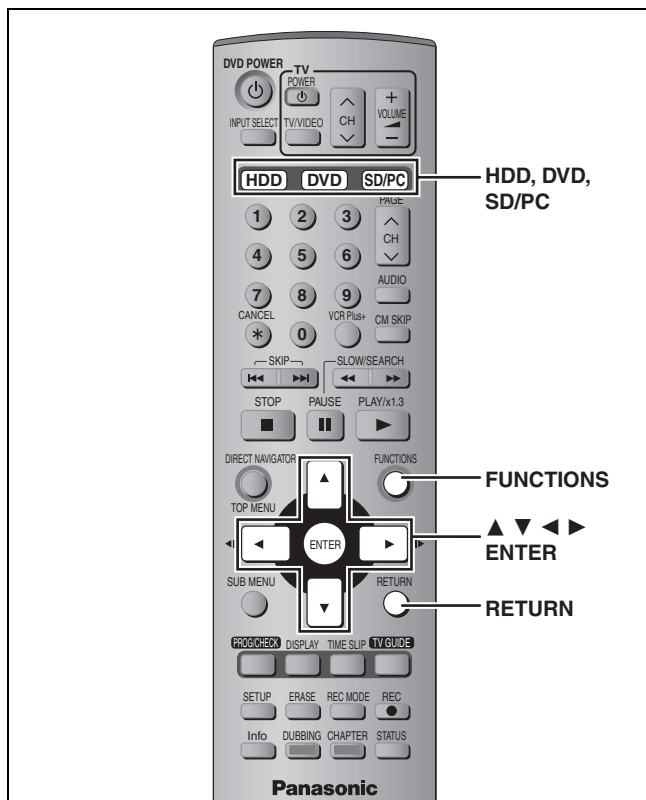

## Setting the protection

### ■ Setting the protection for the whole disc or card

- For a DVD-RAM with a cartridge or for a card

#### RAM

With the write-protect tab in the protect position, play automatically starts when inserted in the unit.



#### SD PC

Switch the write-protect switch to the "LOCK" position.

e.g. SD Memory Card



- For a DVD-RAM without a cartridge (⇒ below, Disc Protection)

### ■ Other protection settings

#### Title

Select "Set up Protection" in step 4 on page 32.

#### Still picture

Select "Set up Protection" in step 4 on page 36.

#### Folder of still pictures

Select "Set up Protection" in step ③ on page 36, "To edit still picture folders".

## Disc Protection

#### RAM

#### Preparation

Press [DVD] to select the DVD drive.

- 1 While stopped  
Press [FUNCTIONS].
- 2 Press [▲, ▼, ◀, ▶] to select "DISC SETTING" and press [ENTER].
- 3 Press [▲, ▼] to select "Disc Protection" and press [ENTER].

- 4 Press [◀, ▶] to select "Yes" and press [ENTER].

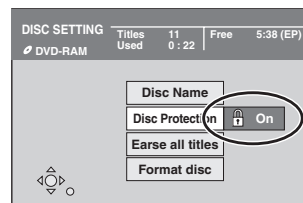

The lock symbol appears closed when the disc is write-protected.

## Providing a disc with a name

#### RAM DVD-R

#### Preparation

- Press [DVD] to select the DVD drive.
- Release protection (⇒ left).

- 1 While stopped  
Press [FUNCTIONS].
- 2 Press [▲, ▼, ◀, ▶] to select "DISC SETTING" and press [ENTER].
- 3 Press [▲, ▼] to select "Disc Name" and press [ENTER].  
⇒ page 46, Entering text

- The disc name is displayed in the FUNCTIONS window.
- With a finalized DVD-R, the name is displayed on the Top Menu.

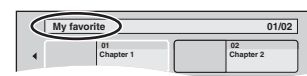

## Erasing all titles and play lists—Erase all titles

#### HDD RAM

#### Preparation

- Press [HDD] or [DVD] to select the drive.
- Release protection (⇒ left).

- 1 While stopped  
Press [FUNCTIONS].
- 2 Press [▲, ▼, ◀, ▶] to select "DISC SETTING" and press [ENTER].
- 3 Press [▲, ▼] to select "Erase all titles" and press [ENTER].
- 4 Press [◀, ▶] to select "Yes" and press [ENTER].
- 5 Press [◀, ▶] to select "Start" and press [ENTER].  
A message appears when finished.
- 6 Press [ENTER].

#### Note

- Once erased, the recorded contents are lost and cannot be restored. Make certain before proceeding.
- Still picture data (JPEG, TIFF) or computer data cannot be erased.
- Erase does not work if one or more titles are protected.

## Erasing all the contents of a disc or card—Format

HDD RAM SD PC

### Preparation

- Press [HDD], [DVD] or [SD/PC] to select the drive.
- Release protection (→ page 44).

- 1 While stopped  
Press [FUNCTIONS].
- 2 Press [▲, ▼, ◀, ▶] to select “DISC SETTING” or “CARD SETTING” and press [ENTER].
- 3 Press [▲, ▼] to select “Format” or “Format disc” and press [ENTER].
- 4 Press [◀, ▶] to select “Yes” and press [ENTER].
- 5 Press [◀, ▶] to select “Start” and press [ENTER].  
A message appears when formatting is finished.
- 6 Press [ENTER].

### Note

- Formatting erases all contents (including computer data), and it cannot be restored. Check carefully before proceeding. The contents are erased when you format it even if you have set protection.
- Do not disconnect the AC power supply cord while formatting. This can render the disc unusable. Formatting normally takes a few minutes, however it may take up to a maximum of 70 minutes (RAM).

### To stop formatting RAM

- Press [RETURN].  
(You can cancel formatting if it takes more than 2 minutes. The disc must be reformatted if you do this.)
- Formatting cannot be performed on DVD-R or CD-R/RW.
  - When a disc or card has been formatted using this unit, it may not be possible to use it on any other equipment.
  - You cannot format a Microdrive or mobile hard disk on this unit.

## Enabling DVD-R to be played on other equipment—Finalize

DVD-R

### Preparation

Press [DVD] to select the DVD drive.

- 1 While stopped  
Press [FUNCTIONS].
- 2 Press [▲, ▼, ◀, ▶] to select “DISC SETTING” and press [ENTER].

### 3 Press [▲, ▼] to select “TOP MENU” and press [ENTER].

Press [▲, ▼, ◀, ▶] to select the background and press [ENTER].

You can select the background that will be displayed as the DVD-Video top menu after finalizing.

- You can change thumbnails displayed in the top menu. (→ page 33, Change Thumbnail)

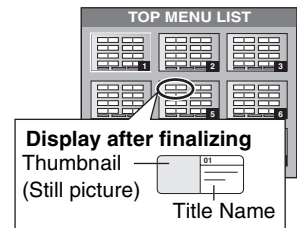

### 4 Press [▲, ▼] to select “Select First play” and press [ENTER].

Press [▲, ▼] to select “Top Menu” or “Title 1” and press [ENTER].

You can select whether to show the top menu after finalizing. Top Menu: The top menu appears first.

Title 1: The disc content is played without displaying the top menu.

### 5 Press [▲, ▼] to select “Finalize” and press [ENTER].

- ① Press [◀, ▶] to select “Yes” and press [ENTER].
- ② Press [◀, ▶] to select “Start” and press [ENTER].  
A message appears when finalizing is finished.
- ③ Press [ENTER].

### Note

#### After finalizing

- The disc becomes play-only and you can no longer record or edit.
- When transferring (dubbing) in high speed, chapters will be replicated.
- Titles are divided into about 5-minute\* chapters, if
  - the titles were directly recorded to DVD-R.
  - the titles were transferred (dubbed) using any mode other than the high speed mode.
- \* This time varies greatly depending on the condition and mode of recording.
- There is a pause of several seconds between titles and chapters during play.

#### Do not disconnect the AC power supply cord while finalizing. This will render the disc unusable.

- Finalizing takes up to 15 minutes.
- You cannot finalize DVD-R recorded on other manufacturer’s equipment.
- If you finalize a recorded DVD-R on Panasonic equipment other than this unit, the background selected as “TOP MENU” may not display.

	Before finalizing	After finalizing
Disc display on this unit	DVD-R	DVD-V
Recording/Editing/Entering name	○	×
Play on other players	×	○

DVD-R finalized on this unit may not be playable on other players due to the condition of the recording.

- Visit Panasonic’s homepage for more information about DVDs.  
<http://www.panasonic.com/broadcast>

### To exit the screen

Press [RETURN] several times.

### To return to the previous screen

Press [RETURN].

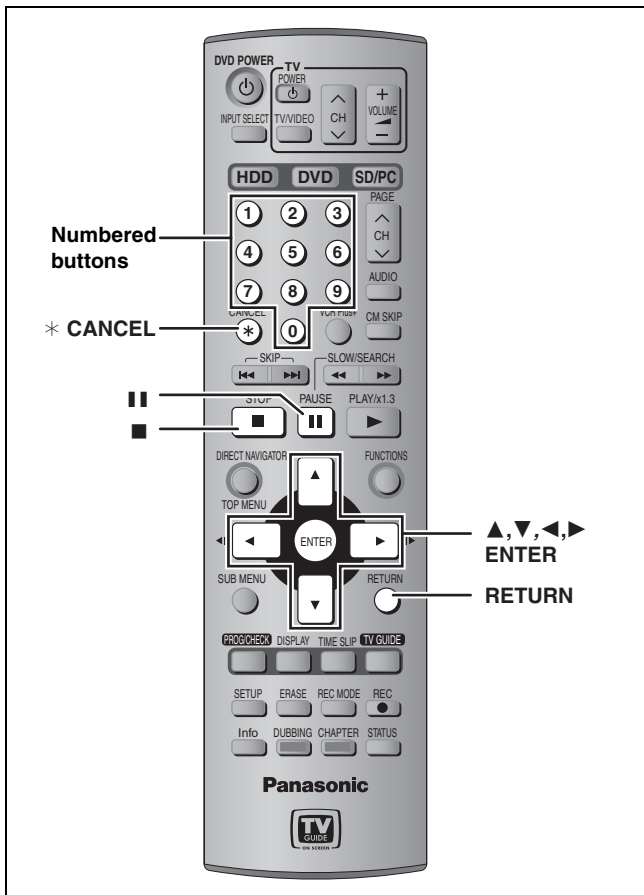

**HDD RAM DVD-R SD PC**

You can give names to recorded titles, etc.

The maximum number of characters:

<b>HDD RAM</b>	Characters
Title	64
Play list	64
Disc	64
Folder of still pictures	36

<b>DVD-R</b>	Characters
Title	44
Disc	40

<b>SD PC</b>	Characters
Folder of still pictures	36

**Note**

If a name is long, parts of it may not be shown in some screens.

## 1 Show Enter Name screen.

**Title**

Select "Enter Name" in step 4 on page 32.

**Play list**

Select "Enter Name" in step 4 on page 35.

**Disc**

Select "Disc Name" in step 3 on page 44.

**Folder of still pictures**

Select "Folder Name" in step ③ on page 36, "To edit still picture folders".

**Name field:** shows the text you have entered

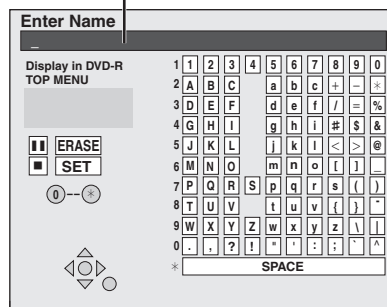

## 2 Press [▲, ▼, ◀, ▶] to select a character and press [ENTER].

Repeat this step to enter other characters.

**•To erase a character**

Press [▲, ▼, ◀, ▶] to select the character in the name field and press [■].

**•Using the numbered buttons to enter characters**

e.g., entering the letter "R"

- ① Press [7] to move to the 7th row.
- ② Press [7] twice to highlight "R".
- ③ Press [ENTER].

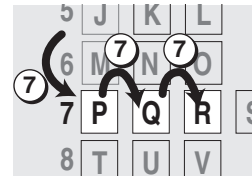

**•To enter a space**

Press [\* CANCEL] and press [ENTER].

## 3 Press [■] (SET).

Returns to the previously displayed screen.

**To end partway**

Press [RETURN].  
Text is not saved.

**For your reference**

If you enter a long name, only part of it is shown in the TOP MENU after finalization (➡ page 45). When entering a title name, the name that will appear in the TOP MENU can be previewed in "Display in DVD-R TOP MENU" window.

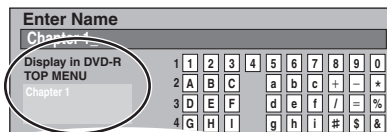

# Changing the unit's settings

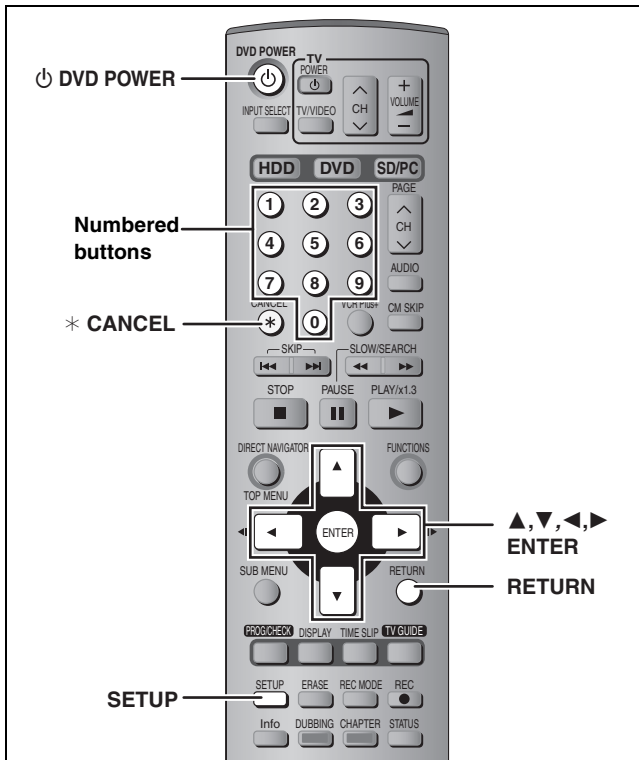

## Common procedures

- 1 While stopped  
Press [SETUP].
- 
- 2 Press [ $\blacktriangle$ ,  $\blacktriangledown$ ] to select the tab and press [ $\blacktriangleright$ ].
  - 3 Press [ $\blacktriangle$ ,  $\blacktriangledown$ ] to select the menu and press [ENTER].
  - 4 Press [ $\blacktriangle$ ,  $\blacktriangledown$ ] to select the option and press [ENTER].

### To exit the screen

Press [SETUP].

### To return to the previous screen

Press [RETURN].

## Summary of settings

The settings remain intact even if you switch the unit to standby.

\*1 You need to set these menus only when you do not use TV Guide On Screen™ system. These menus turn gray and become un-selectable after this unit downloads the television program list.

\*2 You can set these menus only after "Auto Channel Setting" is completed.



	Tabs	Menus	Options (Underlined items are the factory presets.)	
<b>Channel</b>	<b>TV GUIDE Setting</b> Set the TV Guide On Screen™ system.			
	<b>Antenna System</b> *2 Select to suit the type of antenna you are using.	•TV	• <u>CATV</u>	
	<b>Auto Channel Setting</b> *1 (⇒ page 50)	–		
	<b>Preset Channel Captions</b> *2 (⇒ page 51)	–		
	<b>Manual Channel Captions</b> *2 (⇒ page 51)	–		
<b>Set Up</b>	<b>Off Timer</b> Select how long the unit remains on when it is not being used.	•2 hr	• <u>6 hr</u> •Off	
	<b>Remote Control Code</b> (⇒ page 13)	• <u>Set Code 1</u>	•Set Code 2 •Set Code 3	
	<b>Auto Clock Setting</b> *1 (⇒ page 50)			
	<b>Manual Clock Setting</b> *1 (⇒ page 11)			
	<b>Time Zone Adjust</b> *1 (⇒ page 50)	•–1	• <u>0</u> •+1	
<b>Re-initialize Settings</b> This returns all values in the SETUP menus, except for the clock, channel settings, ratings level, and on-screen language, to the default settings.	•Yes	• <u>No</u>		
<b>Disc</b>	<b>Languages</b> Choose the language for audio, subtitle and disc menus. <b>DVD-V</b> •Press [ENTER] to show the following settings. •Some discs start in a certain language despite any changes you make here.		•Enter a code (⇒ page 56) with the numbered buttons when you select "Other ****". When the selected language is not available on the disc, the default language is played. There are discs where you can only switch the language from the menu screen (⇒ page 24).	
	<b>Audio Language</b>	• <u>English</u>	•French •Spanish •Original: The original language of each disc will be selected. •Other ****	
	<b>Subtitle Language</b>	• <u>Automatic</u> : If the language selected for "Audio Language" is not available, subtitles of that language will automatically appear if available on that disc.	•English •French •Spanish •Other ****	
	<b>Menu Language</b>	• <u>English</u>	•French •Spanish •Other ****	

Continued on next page

Tabs	Menus	Options (Underlined items are the factory presets.)									
Disc Continued	<b>Ratings</b> Set a ratings level to limit DVD-Video play.  Follow the on-screen instructions. Enter a 4-digit password with the numbered buttons when the password screen is shown. ● Do not forget your password.	● <u>8 No Limit</u> : All DVD-Video can be played. ● <u>1 to 7</u> : Prohibits play of DVD-Video with corresponding ratings recorded on them. ● <u>0 Lock All</u> : Prohibits play of all DVD-Video.									
	<b>Recording Time in EP Mode</b> Select the maximum number of hours for recording in EP mode (⇒ page 17, Recording modes and approximate recording times).	● <u>EP (6H)</u> : You can record for 6 hours on an unused 4.7 GB disc. ● <u>EP (8H)</u> : You can record for 8 hours on an unused 4.7 GB disc.									
	<b>Play DVD-Audio in Video Mode</b> Select "Video (On)" to play DVD-Video content on some DVD-Audio.	● <u>Video (On)</u> : The setting returns to "Audio (Off)" when you change the disc or turn the unit off. ● <u>Audio (Off)</u>									
	<b>DVD-R High-Speed Recording</b> When high speed transferring (dubbing) a title to DVD-R, it is necessary to turn this setting "On" before recording to HDD; however, the screen size, etc. is restricted (⇒ right). We recommend turning the setting "Off" if high speed transfer (dubbing) to DVD-R is not necessary when recording a program.	● <u>On</u> : Makes high speed mode transferring (dubbing) to DVD-R possible. Press [◀, ▶] to select "Yes" and press [ENTER]. ["▶▶▶"] appears in the transferring (dubbing) list (⇒ page 38). – Pictures are saved at 4:3. – Hybrid VBR Resolution (⇒ below) setting is "Fixed". – Select the type of audio in advance from "Select MTS" (⇒ below).  ● <u>Off</u>									
Video	<b>3-D Y/C Separation</b>	● <u>On</u> : Reduces noise by separating the luminance (Y) and color (C) signals when recording. ● <u>Off</u> : Reduces the ghosting that occurs when recording fast moving images.									
	<b>Hybrid VBR Resolution</b> (⇒ page 53, VBR)	● <u>Automatic</u> : The resolution is automated to provide efficient recording with less block noise. <b>HDD RAM</b> ● <u>Fixed</u> : The resolution is fixed to ensure that there is no loss of source picture resolution while recording.									
	<b>Still Mode</b> Select the type of picture shown when you pause play (⇒ page 53, Frames and fields).	● <u>Automatic</u> ● <u>Field</u> : Select if jittering occurs when "Automatic" is selected. ● <u>Frame</u> : Select if small text or fine patterns cannot be seen clearly when "Automatic" is selected.									
	<b>Seamless Play</b> Select the play mode for play list chapter segments.	● <u>On</u> : The chapters in play lists are played seamlessly. This does not work when there are several audio types included on the play list and when using Quick View. Additionally, the positioning of chapter segments may change slightly. ● <u>Off</u> : The points where chapters in play lists change are played accurately, but the picture may freeze for a moment.									
	<b>Line-in NR</b> Reduces video tape noise while transferring (dubbing). ● When noise reduction is on, "3-D Y/C Separation" (⇒ above) does not work regardless of the setting.	● <u>Automatic</u> : Noise reduction only works on picture input from a video tape. ● <u>On</u> : Noise reduction works for any video input. ● <u>Off</u> : Noise reduction is off. Select when you want to record input as is.									
	<b>Black Level Control</b> Select normal, lighter or darker for adjusting the black level control to the desired setting for picture enhancement.										
		<table border="0"> <tr> <td><b>Input Level</b> Adjusts the black level of the input signal.</td> <td>● <u>Lighter</u></td> <td>● <u>Darker</u></td> </tr> <tr> <td><b>Output Level (Composite/S Video)</b> Adjusts the black level of the output signal from the VIDEO OUT and S-VIDEO OUT terminal.</td> <td>● <u>Lighter</u></td> <td>● <u>Darker</u></td> </tr> <tr> <td><b>Output Level (Component)</b> Adjusts the black level of the output signal from the COMPONENT VIDEO OUT (Y/P<sub>B</sub>/P<sub>R</sub>) terminals.</td> <td>● <u>Lighter</u></td> <td>● <u>Normal</u></td> <td>● <u>Darker</u></td> </tr> </table>	<b>Input Level</b> Adjusts the black level of the input signal.	● <u>Lighter</u>	● <u>Darker</u>	<b>Output Level (Composite/S Video)</b> Adjusts the black level of the output signal from the VIDEO OUT and S-VIDEO OUT terminal.	● <u>Lighter</u>	● <u>Darker</u>	<b>Output Level (Component)</b> Adjusts the black level of the output signal from the COMPONENT VIDEO OUT (Y/P <sub>B</sub> /P <sub>R</sub> ) terminals.	● <u>Lighter</u>	● <u>Normal</u>
<b>Input Level</b> Adjusts the black level of the input signal.	● <u>Lighter</u>	● <u>Darker</u>									
<b>Output Level (Composite/S Video)</b> Adjusts the black level of the output signal from the VIDEO OUT and S-VIDEO OUT terminal.	● <u>Lighter</u>	● <u>Darker</u>									
<b>Output Level (Component)</b> Adjusts the black level of the output signal from the COMPONENT VIDEO OUT (Y/P <sub>B</sub> /P <sub>R</sub> ) terminals.	● <u>Lighter</u>	● <u>Normal</u>	● <u>Darker</u>								
Audio	<b>Search Audio &amp; PLAY ×1.3</b> You may hear sound regardless of this setting with some discs.	● <u>On</u> : Audio is heard during first level search forward. ● <u>Off</u> : Audio is not heard during search. Quick View (⇒ page 25) does not work.									
	<b>D. Range Compression <b>DVD-V</b></b> (Dolby Digital only) Change the dynamic range for late night viewing.	● <u>On</u>	● <u>Off</u>								
	<b>Select MTS</b> Select the audio recording type, main or secondary (SAP) audio when: – Recording or transferring (dubbing) to a DVD-R. – Recording or transferring (dubbing) sound in LPCM. (⇒ page 49, Audio for XP Recording)	● <u>Main</u>	● <u>SAP</u> You cannot select this when recording from an external source onto DVD-R. Select audio on the other equipment.								

Continued on next page



<b>Audio</b> Continued	<b>Digital Audio Output</b> Change the settings when you have connected equipment through this unit's DIGITAL AUDIO OUT terminal (⇒ page 9). ● Press [ENTER] to show the following settings.	
	<b>PCM Down Conversion</b> Select how to output audio with a sampling frequency of 96 kHz or 88.2 kHz.	<ul style="list-style-type: none"> <li>● <u>On</u>: Signals are converted to 48 kHz or 44.1 kHz. (Choose when the connected equipment cannot process signals with sampling frequency of 96 kHz or 88.2 kHz.)</li> <li>● <u>Off</u>: Signals are output as 96 kHz or 88.2 kHz. (Choose when the connected equipment can process signals with sampling frequency of 96 kHz or 88.2 kHz.)</li> </ul> Signals are converted to 48 kHz or 44.1 kHz despite the above settings if the signals have a sampling frequency of over 96 kHz or 88.2 kHz, or the disc has copy protection.
	 <b>Dolby Digital</b> Select how to output the signal, to output "Bitstream" so the connected equipment decodes the signal, or to decode on this unit and output the signal as "PCM" (2 channel).	<ul style="list-style-type: none"> <li>● <u>Bitstream</u>: When connecting to equipment displaying the Dolby Digital logo.</li> <li>● <u>PCM</u>: When connecting to equipment not displaying the Dolby Digital logo.</li> </ul>
	 <b>DTS</b> Select how to output the signal, to output "Bitstream" so the connected equipment decodes the signal, or to decode on this unit and output the signal as "PCM" (2 channel). <b>Note</b> Not making the proper settings may result in noise, possibly damage your hearing and speakers, and digital recording may not work properly.	<ul style="list-style-type: none"> <li>● <u>Bitstream</u>: When connecting to equipment displaying the DTS logo.</li> <li>● <u>PCM</u>: When connecting to equipment not displaying the DTS logo.</li> </ul>
	<b>Audio for XP Recording</b> Choose the audio type when recording or transferring (dubbing) with XP mode.	<ul style="list-style-type: none"> <li>● <u>Dolby Digital</u> (⇒ page 53)</li> <li>● <u>LPCM</u> (⇒ page 53)               <ul style="list-style-type: none"> <li>–The picture quality of LPCM recordings may be lower than that of normal XP mode recordings.</li> <li>–The audio recording becomes Dolby Digital even if you selected LPCM when using a recording mode other than XP.</li> <li>–When recording MTS broadcast, select the type of audio in advance from "Select MTS" (⇒ page 48).</li> </ul> </li> </ul>
<b>Select Audio CH for DV Input</b> You can select the kind of audio when recording from the unit's DV terminal (⇒ page 41).	<ul style="list-style-type: none"> <li>● <u>Stereo 1</u>: Records audio (L1, R1).</li> <li>● <u>Stereo 2</u>: Records added audio such as narration (L2, R2) subsequent to original recording.</li> <li>● <u>Mix</u>: Records both Stereo 1 and Stereo 2.</li> </ul> When recording MTS broadcast, select the type of audio in advance from "Select MTS" (⇒ page 48).	
<b>Display</b>	<b>Status Messages</b> Choose whether to show status messages automatically.	<ul style="list-style-type: none"> <li>● <u>Automatic</u></li> <li>● <u>Off</u></li> </ul>
	<b>On-screen Language</b> Choose the language for these menus and on-screen messages.	<ul style="list-style-type: none"> <li>● <u>English</u></li> <li>● <u>Español</u></li> <li>● <u>Français</u></li> </ul> –Only English is displayed in the TV Guide On Screen™ system regardless of the settings. Other languages cannot be displayed.
	<b>Blue Background</b> Select "Off" if you do not want to have the unit show the blue background when reception is weak.	<ul style="list-style-type: none"> <li>● <u>On</u></li> <li>● <u>Off</u></li> </ul>
	<b>Front Display</b> Changes the brightness of the unit's display.	<ul style="list-style-type: none"> <li>● <u>Bright</u></li> <li>● <u>Dim</u></li> <li>● <u>Automatic</u>: The display turns dark during play, and reappears momentarily if a button is pressed. When the unit is turned off all displays disappear. While using this mode the standby power consumption can be reduced.</li> </ul>
<b>TV Screen</b>	<b>TV Type</b> (⇒ page 12)	<ul style="list-style-type: none"> <li>● <u>Aspect 4:3 &amp; 480i</u></li> <li>● <u>Aspect 16:9 &amp; 480i</u></li> <li>● <u>Aspect 4:3 &amp; 480P</u></li> <li>● <u>Aspect 16:9 &amp; 480P</u></li> </ul>
	<b>4:3 TV Settings for DVD-Video</b> Select how DVD-Video widescreen picture is shown on a 4:3 standard aspect television.	<ul style="list-style-type: none"> <li>● <u>Pan &amp; Scan</u>: Video recorded for a widescreen is played as Pan &amp; Scan (unless prohibited by the producer of the disc).</li> <li>● <u>Letterbox</u>: Video recorded for a widescreen is played in the letterbox style.</li> </ul>
	<b>4:3 TV Settings for DVD-RAM</b> Select how DVD-RAM widescreen picture is shown on a 4:3 standard aspect television.	<ul style="list-style-type: none"> <li>● <u>4:3</u>: Titles played as recorded.</li> <li>● <u>Pan &amp; Scan</u>: Video recorded for a widescreen is played as Pan &amp; Scan.</li> <li>● <u>Letterbox</u>: Video recorded for a widescreen is played in the letterbox style.</li> </ul>

Refer to the control reference on page 47.

## Preparation:

If the television program list has already been downloaded, return the unit to the factory preset condition using the steps indicated below.

When the unit is on and stopped

- ① Press and hold [v CH] and [^ CH] on the main unit for about five seconds.  
The unit turns off.
- ② Press [⏻ DVD POWER] to turn the unit on.
- ③ Complete the TV Guide On Screen™ system setup (until [ENTER] is pressed after the “Watch TV” message screen is displayed).

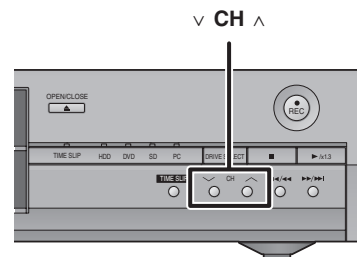

## Note

You can set timer recording only manually after you set the unit with “Auto Channel Setting”.

## Auto channel/clock settings

- 1 Press [SETUP].
- 2 Press [▲, ▼] to select “Channel” and press [▶].
- 3 Press [▲, ▼] to select “Auto Channel Setting” and press [ENTER].
- 4 Press [◀, ▶] to select “Yes” and press [ENTER].
- 5 Press [ENTER].

Auto Channel Setting starts. This takes a few minutes. The unit then proceeds with Auto Clock Setting. The time is displayed when finished.

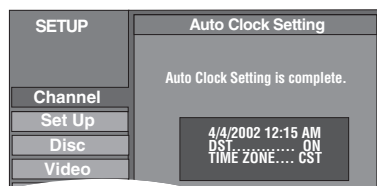

- DST, Daylight Saving Time, shows the summertime setting.
- TIME ZONE shows the time difference from Greenwich meantime (GMT).

EST (Eastern Standard Time) = GMT -5  
 CST (Central Standard Time) = GMT -6  
 MST (Mountain Standard Time) = GMT -7  
 PST (Pacific Standard Time) = GMT -8  
 AST (Alaska Standard Time) = GMT -9  
 HST (Hawaii Standard Time) = GMT -10  
 For other areas: xx hr

- If the Auto Clock Setting does not start automatically, select “Auto Clock Setting” from the “Set Up” tab.
- If the time was not set correctly, use manual clock setting (→ page 11) or time zone adjust.

- 6 Press [ENTER].

- The unit configures channels according to the Antenna System settings as follows.

Antenna system	Band	Channel
TV	VHF	2-13
	UHF	14-69
CATV	VHF	2-13
	CATV LOW BAND	95-99
	CATV MID/SUPER BAND	14-36
	CATV HYPER BAND	37-65
	ULTRA BAND	66-94
	SPECIAL CATV CHANNEL	100-125
		1

## Time Zone Adjust

Adjust the time zone (-1 or +1) if it was not set correctly with auto clock setting.

You cannot change this setting if you set the clock manually.

- 1 Press [SETUP].
- 2 Press [▲, ▼] to select “Set Up” and press [▶].
- 3 Press [▲, ▼] to select “Time Zone Adjust” and press [ENTER].

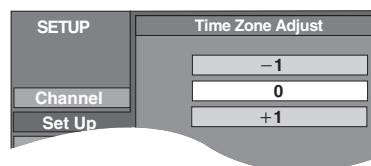

- 4 Press [▲, ▼] to select “-1” or “+1” and press [ENTER].

## To exit the screen

Press [SETUP].

## To return to the previous screen

Press [RETURN].

## To cancel partway while Auto Channel/Clock Setting is taking place

Press [RETURN].

## Channel captions

You can use the preset captions, or manually enter new ones yourself.

The captions you enter are displayed when the channel is displayed and in the Direct Navigator screen.

- You can set channel captions only after “Auto Channel Setting” is completed.

### 1 Press [SETUP].

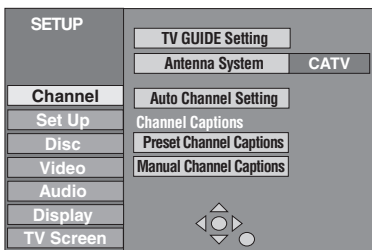

### 2 Press [▲, ▼] to select “Channel” and press [▶].

#### Preset Channel Captions

### 3 Press [▲, ▼] to select “Preset Channel Captions” and press [ENTER].

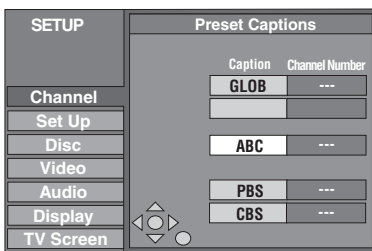

### 4 Press [▲, ▼] to select the caption and press [▶].

You can choose from the following captions.

ABC, PBS, CBS, CNN, FOX, ESPN, NBC, HBO, A&E, AMC, FAM, MAX, MTV, SHOW, TBS, USA, TNT, CBC, UPN, CTV, WB, TSN, DSC, GLOB

- When selecting the caption, press and hold [▲, ▼] to scroll up and down the screen.

### 5 Press [▲, ▼] to select the channel corresponding to the caption and press [◀].

- Channels are only displayed if they contain a station and if captions have not been added manually.
- To delete the channel number, press [\* CANCEL].

Repeat steps 4 and 5 to enter other channels.

### 6 Press [ENTER].

#### Manual Channel Captions

### 3 Press [▲, ▼] to select “Manual Channel Captions” and press [ENTER].

### 4 Press [▲, ▼] to select the channel and press [▶].

- Channels are only displayed if they contain a station and if preset captions have not been added.

### 5 Press [▲, ▼] to select the first character and press [▶].

- You can choose from the following characters:  
A–Z, 0–9, -, &, !, /, (space)
- To delete the caption, press [\* CANCEL].
- Repeat this step to enter the other characters.

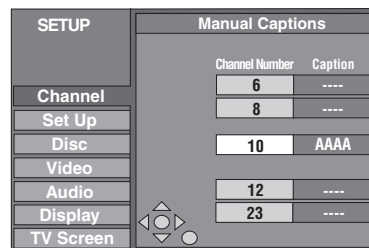

### 6 Press [◀, ▶] to return to the “Channel Number” column.

Repeat steps 4–6 to enter other channels.

### 7 Press [ENTER].

#### To exit the screen

Press [SETUP].

#### To return to the previous screen

Press [RETURN].

# Specifications

**Recording system:** DVD Video Recording format (DVD-RAM)  
DVD-Video format (DVD-R)

**Recordable discs:**  
DVD-RAM :  
12 cm (5") 4.7 GB, 12 cm (5") 9.4 GB, 8 cm (3") 2.8 GB  
12 cm (5") 4.7 GB (Ver. 2.1/3×-SPEED DVD-RAM Revision 1.0)  
DVD-R :  
12 cm (5") 4.7 GB, 8cm (3") 1.4 GB (for General Ver. 2.0)  
12 cm (5") 4.7 GB (for General Ver. 2.0/4×-SPEED DVD-R  
Revision 1.0)

**Recording time:**  
●Maximum 8 hours (with 4.7 GB disc)  
XP: Approx. 1 hour SP: Approx. 2 hours  
LP: Approx. 4 hours EP: Approx. 6 hours/8 hours  
●Maximum 284 hours (with built-in 160 GB HDD)  
XP: Approx. 36 hours SP: Approx. 70 hours  
LP: Approx. 138 hours EP: Approx. 212 hours/284 hours

**Playable discs:**  
DVD-RAM :  
12 cm (5") 4.7 GB, 12 cm (5") 9.4 GB, 8 cm (3") 2.8 GB  
12 cm (5") 4.7 GB (Ver. 2.1/3×-SPEED DVD-RAM Revision 1.0)  
DVD-R :  
12 cm (5") 4.7 GB, 8cm (3") 1.4 GB (for General Ver. 2.0)  
12 cm (5") 4.7 GB (for General Ver. 2.0/4×-SPEED DVD-R  
Revision 1.0)  
DVD-Video, DVD-Audio, Video CD, CD-Audio (CD-DA)  
CD-R/CD-RW (MP3, CD-DA, Video CD formatted discs)

**Built-in HDD Capacity:** 160 GB  
**Drive unit:** High Speed Drive (correspond to 4 times speed with  
DVD-R disc and 3 times speed with DVD-RAM disc)

**LASER Specification**  
Class I LASER Product  
**Wave length:**  
795 nm wavelength (for CDs), 658 nm wavelength (for DVD)  
**Laser power:**  
No hazardous radiation is emitted with the safety protection

**Audio system**  
**Recording system:**  
Dolby Digital 2 ch, Linear PCM (XP mode, 2ch)  
**Input:** LINE (pin jack)×3  
Reference input: 309 mVrms, FS: 2 Vrms (1 kHz, 0 dB)  
Input Impedance: 47 kΩ  
**Output:** LINE (pin jack)×2  
(Load impedance: 10 kΩ)  
Reference output: 309 mVrms, FS: 2 Vrms (1 kHz, 0 dB)  
Output Impedance: 1 kΩ  
**Digital Audio Out:** Optical terminal (PCM, Dolby Digital, DTS)

**Television system**  
**Tuner system:** NTSC-M  
**Antenna reception input:** TV Channel: 2 ch-69 ch, 75 Ω  
CATV Channel: 1 ch-125 ch, 75 Ω  
**RF Converter Output:** Not provided

**Video system**  
**TV system:** NTSC color signal, 525 lines, 60 fields  
**Recording system:** MPEG2 (Hybrid VBR)  
**Input:** LINE (pin jack)×3, 1.0 Vp-p; 75 Ω  
S connector×3 Y: 1.0 Vp-p; C: 0.286 Vp-p; 75 Ω  
**Output:** LINE (pin jack)×2, 1.0 Vp-p; 75 Ω  
S connector×2 Y: 1.0 Vp-p; C: 0.286 Vp-p; 75 Ω  
**Component video output (480P/480I):** Y: 1.0 Vp-p; 75 Ω  
Pb: 0.7 Vp-p; 75 Ω  
Pr: 0.7 Vp-p; 75 Ω

**Card unit:** Still picture (JPEG, TIFF)  
**Card slot:** SD Memory Card/PC Card Type II  
**Compatible media:** SD Memory Card\*, MultiMediaCard  
A PC Card adaptor conforming to PC Card Standards,  
ATA Flash PC Card,  
PC Card adaptor (SD Memory Card\*, MultiMediaCard,  
CompactFlash, SmartMedia, MEMORYSTICK, xD-Picture Card,  
Microdrive), Mobile hard disk  
**Format:** FAT12, FAT16  
**Image format:** JPEG

DCF (Design rule for Camera File system),  
(sub sampling 4:2:2 or 4:2:0),  
TIFF (uncompressed RGB chunky),  
DPOF Compatible  
**Number of pixels:** 34×34 to 6144×4096  
**Thawing time:** Approx. 7 sec. (2 M pixels)  
**DV input:** IEEE 1394 Standard, 4 pin

**Others**  
**Regional code:** # 1  
**Clock unit:** Quartz-controlled 12-hour digital display  
**Operating temperature:** 5 °C-40 °C (41 °F-104 °F)  
**Operating humidity range:** 10 %-80 % RH (no condensation)  
**Power supply:** AC 120 V, 60 Hz  
**Power consumption:** 39 W  
**Dimensions (W×H×D):** Approx. 430 mm×79 mm×291 mm  
(Approx. 16<sup>15</sup>/<sub>16</sub>"×3<sup>1</sup>/<sub>8</sub>"×11<sup>15</sup>/<sub>32</sub>")  
**Mass:** Approx. 4.5 kg (9.9 lbs)

**Power consumption in standby mode: approx. 15 W**

**Note**  
Specifications are subject to change without notice.  
Mass and dimensions are approximate.  
\* Includes miniSD™ Cards. (A miniSD™ adaptor needs to be inserted.)

**User memo:**

DATE OF PURCHASE	_____
DEALER NAME	_____
DEALER ADDRESS	_____
TELEPHONE NUMBER	_____

The model number and serial number of this product can be found on either the back or the bottom of the unit. Please note them in the space provided below and keep for future reference.

MODEL NUMBER \_\_\_\_\_ DMR-T6070 \_\_\_\_\_

SERIAL NUMBER \_\_\_\_\_

## Bitstream

This is the digital form of multi-channel audio data (e.g., 5.1 channel) before it is decoded into its various channels.

## CPRM (Content Protection for Recordable Media)

CPRM is technology used to protect broadcasts that are allowed to be recorded only once. Such broadcasts can be recorded only with CPRM compatible recorders and discs.

## Dolby Digital

This is a method of coding digital signals developed by Dolby Laboratories. Apart from stereo (2-channel) audio, these signals can also be multi-channel audio. A large amount of audio information can be recorded on one disc using this method.

When recording on this unit Dolby Digital (2 channel) is the default audio.

## Down-mixing

This is the process of remixing the multi-channel audio found on some discs into two channels. It is useful when you want to listen to the 5.1-channel audio recorded on DVDs through your television's speakers. Some discs prohibit down-mixing and this unit can then only output the front two channels.

## DPOF (Digital Print Order Format)

DPOF is the standard printing format for still picture data taken by a digital camera, etc. It is used for automatic printing at a photo developing store or on your home printer.

## Drive

In the instance of this unit, this refers to the hard disk (HDD), disc (DVD), SD card (SD) and PC card (PC). These perform the reading and writing of data.

## DTS (Digital Theater Systems)

This surround system is used in many movie theaters. There is good separation between the channels, so realistic sound effects are possible.

## Dynamic range

Dynamic range is the difference between the lowest level of sound that can be heard above the noise of the equipment and the highest level of sound before distortion occurs.

Dynamic range compression means reducing the gap between the loudest and softest sounds. This means you can listen at low volumes but still hear dialog clearly.

## Film and video

DVD-Video are recorded using either film or video. This unit can determine which type has been used, then uses the most suitable method of progressive output.

Film is 24 or 30 frames per second, with motion picture film generally being 24 frames per second.

Video is 60 fields per second (two fields making up one frame).

## Finalize

A process that makes play of a recorded CD-R, CD-RW, DVD-R, etc. possible on equipment that can play such media. You can finalize DVD-R on this unit.

After finalizing, the disc becomes play-only and you can no longer record or edit.

## Folder

This is a place on the hard disk or memory card where groups of data are stored together. In the case of this unit, it refers to the place where still pictures (JPEG, TIFF) are stored.

## Formatting

Formatting is the process of making media such as DVD-RAM recordable on recording equipment.

You can format the HDD, DVD-RAM and memory cards on this unit. Formatting erases irrevocably all contents.

## Frames and fields

Frames refer to the single images that constitute the video you see on your television. Each frame consists of two fields.

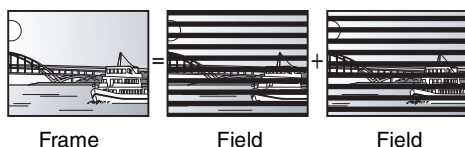

- A frame still shows two fields, so there may be some blurring, but picture quality is generally better.
- A field still shows less picture information so it may be rougher, but there is no blurring.

## HDD (Hard disk drive)

This is a mass data storage device used in computers, etc. A disk with a surface that has been treated with magnetic fluid is spun and a magnetic head is brought in close proximity to facilitate the reading and writing of large amounts of data at high speed.

## JPEG (Joint Photographic Experts Group)

This is a system used for compressing/decoding color still pictures. If you select JPEG as the storage system on digital cameras etc., the data will be compressed to 1/10–1/100 of its original size. The feature of JPEG is less deterioration in picture quality considering the degree of compression.

## LPCM (Linear PCM)

These are uncompressed digital signals, similar to those found on CDs. LPCM sound is available when recording in XP mode.

## MP3 (MPEG Audio Layer 3)

An audio compression method that compresses audio to approximately one tenth of its size without any considerable loss of audio quality. You can play MP3 you have recorded onto CD-R and CD-RW.

## Pan&Scan/Letterbox

In general, DVD-Video are produced with the intention that they be viewed on a widescreen television (16:9 aspect ratio), so images often don't fit regular (4:3 aspect ratio) televisions. Two styles of picture, "Pan & Scan" and "Letterbox", deal with this problem.

Pan&Scan: The sides are cut off so the picture fills the screen.

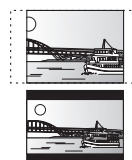

Letterbox: Black bands appear at the top and bottom of the picture so the picture itself appears in an aspect ratio of 16:9.

## Playback control (PBC)

If a Video CD has playback control, you can select scenes and information with menus.

(This unit is compatible with version 2.0 and 1.1.)

## Progressive/Interlace

NTSC, the video signal standard, has 480 interlaced (I) scan lines, whereas progressive scanning uses twice the number of scan lines. This is called 480P.

Using progressive output, you can enjoy the high-resolution video recorded on media such as DVD-Video.

Your television must be compatible to enjoy progressive video.

## Protection

You can prevent accidental erasure by setting writing protection or erasure protection.

## Sampling frequency

Sampling is the process of converting the heights of sound wave (analog signal) samples taken at set periods into digits (digital encoding). Sampling frequency is the number of samples taken per second, so larger numbers mean more faithful reproduction of the original sound.

## Thumbnail

This refers to a miniature representation of a picture used to display multiple pictures in the form of a list.

## TIFF (Tag Image File Format)

This is a system used for compressing/decoding color still pictures. A common format for storing high quality images on digital cameras and other devices.

## VBR (Variable bitrate)

This is a method of video recording that adjusts the bit rate according to video signal.

# Frequently asked questions

Set up		Page
What equipment is necessary to play multi channel surround sound?	<ul style="list-style-type: none"> <li>● DVD-Video: You can play DVD-Video multi channel surround by digitally connecting an amplifier equipped with a Dolby Digital and a DTS decoder.</li> <li>● DVD-Audio: This unit plays DVD-Audio in 2 channels. You cannot play multi channel surround sound.</li> </ul>	9 —
Are the headphones and speakers directly connected to the unit?	<ul style="list-style-type: none"> <li>● You cannot directly connect to the unit. Connect through the amplifier, etc.</li> </ul>	9
The television has both S-VIDEO IN terminal and COMPONENT VIDEO IN terminals. Which terminal should I connect with?	<ul style="list-style-type: none"> <li>● We recommend the COMPONENT VIDEO IN terminal. Component signal outputs the color difference signals (P<sub>B</sub>/P<sub>R</sub>) and luminance signal (Y) separately in order to achieve high fidelity in reproducing colors. If the television is compatible with progressive output, a high quality picture can be output because this unit's component video output terminal outputs a progressive output signal.</li> </ul>	7
Is my television progressive output compatible?	<ul style="list-style-type: none"> <li>● All Panasonic televisions that have 480P input terminals are compatible. Consult the manufacturer if you have another brand of television.</li> </ul>	—

Disc		Page
Can I play DVD-Video, DVD-Audio and Video CDs bought in another country?	<ul style="list-style-type: none"> <li>● You can play them if the video standard is NTSC.</li> <li>● However, you cannot play DVD-Video if their region number does not include "1" or "ALL".</li> </ul>	— <b>Cover</b>
Can a DVD-Video that does not have a region number be played?	<ul style="list-style-type: none"> <li>● The DVD-Video region number indicates the disc conforms to a standard. You cannot play discs that do not have a region number.</li> </ul>	—
Please tell me about DVD-R and DVD-RW compatibility with this unit.	<ul style="list-style-type: none"> <li>● This unit records and plays DVD-R. However, you cannot record onto DVD-R discs that are finalized.</li> <li>● This unit also records and plays high speed recording compatible discs.</li> <li>● This unit does not record or play DVD-RW.</li> </ul>	— — —
Please tell me about CD-R and CD-RW compatibility with this unit.	<ul style="list-style-type: none"> <li>● This unit plays CD-R/CD-RW discs (audio recording discs) which have been recorded under one of the following standards: CD-DA, MP3 and Video CD. Close the session or finalize the disc after recording.</li> <li>● You cannot write to a CD-R or CD-RW with this unit.</li> </ul>	14, 27 —

Recording		Page
Can I record from a commercially purchased video cassette or DVD?	<ul style="list-style-type: none"> <li>● Most commercially sold video cassettes and DVD are copy protected; therefore, recording is usually not possible.</li> </ul>	—
Can a DVD-R recorded on this unit be played on other equipment?	<ul style="list-style-type: none"> <li>● You can play on DVD-R compatible players after finalizing the disc on this unit; however, due to the condition of the recording, play may not be possible.</li> </ul>	45
Can I high speed transfer (dub) to a disc?	<ul style="list-style-type: none"> <li>● You can record up to 32× recording speed to DVD-R and up to 24× recording speed to DVD-RAM when using a high speed compatible disc.</li> </ul>	37
Can I record digital audio signals using this unit?	<ul style="list-style-type: none"> <li>● You cannot record digital signals. The digital audio terminals on this unit are for output only. (The audio recorded using the DV automatic recording function from a digital video camcorder, for example, is recorded digitally.)</li> </ul>	—
Can a digital audio signal from this unit be recorded to other equipment?	<ul style="list-style-type: none"> <li>● You can record if using the PCM signal. When recording DVD, change the "Digital Audio Output" settings to the following from the SETUP menu. <ul style="list-style-type: none"> <li>–PCM Down Conversion    On</li> <li>–Dolby Digital            PCM</li> <li>–DTS                        PCM</li> </ul> </li> <li>● However, only <ul style="list-style-type: none"> <li>–As long as digital recording from the disc is permitted.</li> <li>–As long as the recording equipment is compatible with a sampling frequency of 48 kHz.</li> </ul> </li> <li>● You cannot record MP3 signals.</li> </ul>	49 —
Can I switch to SAP during recording?	<ul style="list-style-type: none"> <li>● With HDD and DVD-RAM, you can, and the audio recorded also changes. Just press [AUDIO].</li> <li>● With DVD-R, you cannot. Change before recording with "Select MTS" in the SETUP menu.</li> </ul>	17 48

## TV Guide On Screen™ system

Page

<p>Does the TV Guide On Screen™ system work with analog and digital cable TV boxes?</p>	<ul style="list-style-type: none"> <li>• Yes. The TV Guide On Screen™ system works with both analog and digital cable TV boxes.</li> </ul>	<p>—</p>
<p>I have relocated, changed my television reception system or cable TV box etc. How should I redo the TV Guide On Screen™ system setup?</p>	<ul style="list-style-type: none"> <li>• Select “Change system settings” in “SETUP” in the Navigation menu of the TV Guide On Screen™ system. If you select “No, repeat setup process”, you can then access the TV Guide On Screen™ system setup screen. You can also access the setup screen from “TV GUIDE Setting” in the SETUP menu.</li> </ul>	<p><b>23, 47</b></p>
<p>Please tell me about the downloading of television program list data.</p>	<ul style="list-style-type: none"> <li>• Channel line-up data is transmitted continuously, 24 hours a day—7 days a week.</li> <li>• Program information that contains details about each program is usually transmitted four times a day, and the cycles last approximately 3 hours. The TV Guide On Screen™ system only requires one transmission a day to maintain up-to-date program listings. Because the unit must be turned off in order to receive new information, multiple transmissions are conveniently scheduled early to mid-morning and early afternoon hours.</li> </ul>	<p>— —</p>
<p>Why doesn't my favorite program have more information in the information window or expanded information window?</p>	<ul style="list-style-type: none"> <li>• The hardware that makes TV Guide On Screen™ system possible is a computer chip which has limited storage space. Factors used in determining which programs display detailed program information are the number of channels turned “ON” in the CHANNEL EDITOR screen and the availability of the descriptions. Setting channels that cannot be received to “OFF” in the CHANNEL EDITOR screen may increase the amount of information displayed.</li> </ul>	<p><b>23</b></p>
<p>What kind of information might be seen in the MESSAGES screen?</p>	<ul style="list-style-type: none"> <li>• Useful Product Related Information (PRI) such as alerting the user to new features or data available through the TV Guide On Screen™ system. This feature may not be active in all viewing areas.</li> </ul>	<p>—</p>
<p>Can I record one channel while watching another?</p>	<p>If you do not connect a cable TV box</p> <ul style="list-style-type: none"> <li>• Yes. Change the television's input mode to “TV”.</li> </ul> <p>If you connect a cable TV box</p> <ul style="list-style-type: none"> <li>• No. The user cannot watch one program and record another.</li> </ul>	<p>— —</p>
<p>If I have a power failure, will I need to reset the timer recording programs I have already set?</p>	<ul style="list-style-type: none"> <li>• In most cases the timer recording programs will be saved. However, if an extended power failure occurs, it is strongly recommended that you verify the timer recording programs that you had previously set. Press [PROG/CHECK] to display the SCHEDULE screen.</li> </ul>	<p><b>21</b></p>
<p>I do not want TV Guide On Screen™ system to automatically appear on screen.</p>	<ul style="list-style-type: none"> <li>• Select “Off” in “Review options” menu, so that TV Guide On Screen™ system appears only when you press [TV GUIDE].</li> </ul>	<p><b>23</b></p>
<p>I do not want to use TV Guide On Screen™ system.</p>	<ul style="list-style-type: none"> <li>• Set the unit with “Auto Channel Setting” in the SETUP menu. Note that you can set timer recording only manually after you set the unit with “Auto Channel Setting”.</li> </ul>	<p><b>50</b></p>

## On the television

		Page
Cannot finish recording completely.	<ul style="list-style-type: none"> <li>The program was copy-protected.</li> <li>The HDD or disc may be full.</li> </ul>	—
Cannot play.	<ul style="list-style-type: none"> <li>You inserted an incompatible disc (Discs recorded in PAL video, etc.).</li> </ul>	—
Cannot record on the disc.	<ul style="list-style-type: none"> <li>The disc may be dirty or scratched.</li> </ul>	62
Please check the disc.	<ul style="list-style-type: none"> <li>You cannot format a Microdrive or mobile hard disk on this unit.</li> </ul>	—
Unable to format.		
Cannot play back on this DVD-Recorder.	<ul style="list-style-type: none"> <li>You tried to play a non-compatible image.</li> <li>Turn the unit off and re-insert the card.</li> </ul>	28 28
Cannot record. Disc is full.	<ul style="list-style-type: none"> <li>Create space by erasing any unnecessary titles. <b>HDD RAM</b></li> </ul>	26, 33, 44,
Cannot record. Maximum number of titles exceeded.	<ul style="list-style-type: none"> <li>(Even if you erase recorded content from the DVD-R, there is no increase in disc space.)</li> <li>Use a new disc.</li> </ul>	45 —
Error has occurred. Please press ENTER.	<ul style="list-style-type: none"> <li>Press [ENTER] to start recovery process. You cannot operate the unit while it is recovering ("SELF CHECK" appears on the unit's display).</li> </ul>	—
No disc	<ul style="list-style-type: none"> <li>The disc may be upside down.</li> </ul>	—
No folders.	<ul style="list-style-type: none"> <li>There is no compatible folder in this unit.</li> </ul>	15
No PC CARD No SD CARD	<ul style="list-style-type: none"> <li>The card is not inserted. If this message is displayed with a compatible card already inserted, turn off the unit, remove and then re-insert the card.</li> </ul>	28
No valid PC card. No valid SD card.	<ul style="list-style-type: none"> <li>The card inserted is not compatible or the card format does not match.</li> </ul>	15
Not enough space on dubbing destination.	<ul style="list-style-type: none"> <li>Create space by erasing any unnecessary items.</li> <li>Erase one or more items registered on the transfer (dubbing) list to ensure that the "Destination Capacity" is not exceeded.</li> </ul>	26, 29, 33, 36, 44, 45 39
Please change the disc.	<ul style="list-style-type: none"> <li>There may be a problem with the disc. Press [▲ OPEN/CLOSE] on the main unit to remove it and check it for scratches or dirt. (The unit turns off automatically after you open the tray.)</li> </ul>	62
This is a non-recordable disc.	<ul style="list-style-type: none"> <li>The unit cannot record on the disc you inserted. Insert a DVD-RAM or unfinalized DVD-R.</li> </ul>	—
This disc is not formatted properly.	<ul style="list-style-type: none"> <li>You inserted an unformatted DVD-RAM. Format the disc with this unit.</li> </ul>	45
⊘	<ul style="list-style-type: none"> <li>The operation is prohibited by the unit or disc.</li> </ul>	—

## On the unit's display

CHK REMOTE □ ("□" stands for a number.)	<ul style="list-style-type: none"> <li>The remote control and main unit are using different codes. Change the code on the remote control.</li> </ul>  <p>Press and hold [ENTER] and the indicated number button at the same time for more than 2 seconds.</p>	13
HARD ERR	<ul style="list-style-type: none"> <li>If there is no change after turning the unit on and off, consult the dealer where the unit was purchased.</li> </ul>	—
HDD SLP	<ul style="list-style-type: none"> <li>In order to extend HDD life, the HDD is in SLEEP mode. Press [HDD] to activate.</li> </ul>	62
NO READ	<ul style="list-style-type: none"> <li>The disc is dirty or badly scratched. The unit cannot record, play, or edit.</li> <li>You have used a DVD-RAM/PD lens cleaner and it has finished. Press [▲ OPEN/CLOSE] on the main unit to eject the disc.</li> </ul>	62 —
PLEASE WAIT	<ul style="list-style-type: none"> <li>Displayed when the unit is started. This is not a malfunction.</li> </ul>	—
SELF CHECK	<ul style="list-style-type: none"> <li>There was a power failure or the AC plug was disconnected while the unit was on. The unit is carrying out its recovery process. Wait until the message disappears.</li> </ul>	—
UNSUPPORT	<ul style="list-style-type: none"> <li>You have inserted a disc the unit cannot play or record on.</li> </ul>	14
U14	<ul style="list-style-type: none"> <li>The unit is hot.</li> <li>The unit switches to standby for safety reasons. Wait for about 30 minutes until the message disappears.</li> <li>Select a position with good ventilation when installing the unit. Do not block the cooling fan on the rear of the unit.</li> </ul>	—
U99	<ul style="list-style-type: none"> <li>The unit fails to operate properly. Press [POWER ⏻/I] on the main unit to switch the unit to standby. Now press [POWER ⏻/I] on the main unit again to turn the unit on.</li> </ul>	—

## Language code list

Enter the code with the numbered buttons.

Abkhazian: 6566	Catalan: 6765	Gujarati: 7185	Lingala: 7678	Rhaeto-Romance: 8277	Tamil: 8465
Afar: 6565	Chinese: 9072	Hausa: 7265	Lithuanian: 7684	Romanian: 8279	Tatar: 8484
Afrikaans: 6570	Corsican: 6779	Hebrew: 7387	Macedonian: 7775	Russian: 8285	Telugu: 8469
Albanian: 8381	Croatian: 7282	Hindi: 7273	Malagasy: 7771	Samoan: 8377	Thai: 8472
Ameharic: 6577	Czech: 6783	Hungarian: 7285	Malay: 7783	Sanskrit: 8365	Tibetan: 6679
Arabic: 6582	Danish: 6865	Icelandic: 7383	Malayalam: 7776	Scots Gaelic: 7168	Tigrinya: 8473
Armenian: 7289	Dutch: 7876	Indonesian: 7378	Maltese: 7784	Serbian: 8382	Tonga: 8479
Assamese: 6583	English: 6978	Interlingua: 7365	Maori: 7773	Serbo-Croatian: 8372	Turkish: 8482
Aymara: 6588	Esperanto: 6979	Irish: 7165	Marathi: 7782	Shona: 8378	Turkmen: 8475
Azerbaijani: 6590	Estonian: 6984	Italian: 7384	Moldavian: 7779	Sindhi: 8368	Twi: 8487
Bashkir: 6665	Faroese: 7079	Japanese: 7465	Mongolian: 7778	Singhalese: 8373	Ukrainian: 8575
Basque: 6985	Fiji: 7074	Javanese: 7487	Nauru: 7865	Slovak: 8375	Urdu: 8582
Bengali, Bangla: 6678	Finnish: 7073	Kannada: 7578	Nepali: 7869	Slovenian: 8376	Uzbek: 8590
Bhutani: 6890	French: 7082	Kashmiri: 7583	Norwegian: 7879	Somali: 8379	Vietnamese: 8673
Bihari: 6672	Frisian: 7089	Kazakh: 7575	Oriya: 7982	Spanish: 6983	Volapük: 8679
Breton: 6682	Georgian: 7565	Kirghiz: 7589	Pashto, Pushto: 8083	Sundanese: 8385	Welsh: 6789
Bulgarian: 6671	German: 6869	Korean: 7579	Persian: 7065	Swahili: 8387	Wolof: 8779
Burmese: 7789	Greek: 6976	Kurdish: 7585	Polish: 8076	Swedish: 8386	Xhosa: 8872
Byelorussian: 6669	Greenlandic: 7576	Laotian: 7679	Portuguese: 8084	Tagalog: 8476	Yiddish: 7473
Cambodian: 7577	Guarani: 7178	Latin: 7665	Punjabi: 8065	Tajik: 8471	Yoruba: 8979
		Latvian, Lettish: 7686	Quechua: 8185		Zulu: 9085



# Troubleshooting guide

Before requesting service, make the following checks. If you are in doubt about some of the check points, or if the remedies indicated in the chart do not solve the problem, [go to http://www.panasonic.com/broadcast](http://www.panasonic.com/broadcast).

The following do not indicate a problem with this unit:

- |                                                                                                                                                                                     |                                                                                                                                                                                                                                             |
|-------------------------------------------------------------------------------------------------------------------------------------------------------------------------------------|---------------------------------------------------------------------------------------------------------------------------------------------------------------------------------------------------------------------------------------------|
| <ul style="list-style-type: none"> <li>●Regular disc rotating sounds.</li> <li>●Poor reception due to atmospheric conditions.</li> <li>●Image disturbance during search.</li> </ul> | <ul style="list-style-type: none"> <li>●Interruptions in reception due to periodic satellite broadcasting breaks.</li> <li>●A sound is heard when the HDD goes into SLEEP mode, or operations are slow to respond in SLEEP mode.</li> </ul> |
|-------------------------------------------------------------------------------------------------------------------------------------------------------------------------------------|---------------------------------------------------------------------------------------------------------------------------------------------------------------------------------------------------------------------------------------------|

## Power

## Page

<b>No power.</b>	●Insert the AC power supply cord securely into a known active AC outlet.	<b>7, 8</b>
<b>The unit switches to standby mode.</b>	<ul style="list-style-type: none"> <li>●This is a power saving feature. Change "Off Timer" in the SETUP menu, if you would prefer.</li> <li>●One of the unit's safety devices is activated. Press [POWER ⏻/⏻] on the main unit to turn the unit on.</li> </ul>	<b>47</b> —

## Displays

<b>The display is dim.</b>	●Change "Front Display" in the SETUP menu.	<b>49</b>
<b>"12:00A" is flashing on the unit's display.</b>	●Set the clock.	<b>11</b>
<b>Compared to the actual recorded time, the remaining time displayed is less.</b>	●The displayed recording/play time is converted from the number of frames at 29.97 frames (equal to 0.999 seconds) to one second. There will be a slight difference between the time displayed and the actual elapsed time (e.g., actual one-hour elapsed time may display as approximately 59 minutes 56 seconds). This does not affect the recording.	—
<b>The time recorded on the disc and the available time shown do not add up.</b>	●Times shown may disagree with actual times.	—
<b>The play time shown for MP3 does not agree with the actual time.</b>	<ul style="list-style-type: none"> <li>●More disc space than the actual recording time is used after recording or editing the DVD-R 200 times or more.</li> <li>●While searching, the elapsed time may not display correctly.</li> <li>●Even if you erase recorded content from the DVD-R, there is no increase in disc space.</li> </ul>	— — —

## TV screen and video

<b>Television reception worsens after connecting the unit.</b>	●This can occur because the signals are being divided between the unit and other equipment. It can be solved by using a signal booster, available from audio-visual suppliers.	—
<b>Status messages do not appear.</b>	●Select "Automatic" in "Status Messages" in the SETUP menu.	<b>49</b>
<b>The blue background does not appear.</b>	●Select "On" in "Blue Background" in the SETUP menu.	<b>49</b>
<b>The 4:3 aspect ratio picture expands left and right.</b>	●Use the television to change the aspect. If your television does not have that function, set "Progressive" in the Video menu to "OFF".	<b>31</b>
<b>Screen size is wrong.</b>	●Check the settings for "TV Type", "4:3 TV Settings for DVD-Video" or "4:3 TV Settings for DVD-RAM" in the SETUP menu.	<b>49</b>
<b>There is a lot of after-image when playing video.</b>	●Change the settings for "3D NR", and "Integrated DNR" to "0" or turn "MPEG-DNR" off if it is on.	<b>31</b>
<b>When playing DVD-Video using progressive output, one part of the picture momentarily appears to be doubled up.</b>	●Set "Progressive" in the Video menu to "OFF". This problem is caused by the editing method or material used on DVD-Video, but should be corrected if you use interlace output.	<b>31</b>
<b>There is no apparent change in picture quality when adjusted with the Video menu in the on-screen menus.</b>	●The effect is less perceivable with some types of video.	—
<b>The images from this unit do not appear on the television.</b>	<ul style="list-style-type: none"> <li>●Make sure that the television is connected to the VIDEO OUT terminal, S-VIDEO OUT terminal or COMPONENT VIDEO OUT terminals on this unit.</li> <li>●Make sure that the television's input setting (e.g., VIDEO 1) is correct.</li> </ul>	<b>7</b> —
<b>Picture is distorted.</b>	●The television isn't compatible with progressive signals. Press and hold [■] and [TIME SLIP] on the main unit at the same time for about 5 seconds. The setting will change to interlace.	—
<b>The channels keep changing.</b>	●When the unit is turned off, it uses the IR Blaster to scan the cable TV box channels and acquire the TV program list data. To watch a cable TV box program (even if not recording) turn the unit back on.	—

Sound		Page	
No sound. Low volume. Distorted sound. Cannot hear the desired audio type.	<ul style="list-style-type: none"> <li>• Check the connections and settings. Check the input mode on the amplifier if you have connected one.</li> <li>• Press [AUDIO] to select the audio.</li> <li>• Turn off V.S.S. in the following cases.                             <ul style="list-style-type: none"> <li>– When using discs that do not have surround sound effects such as Karaoke discs.</li> <li>– When playing MTS broadcast programs.</li> </ul> </li> <li>• The disc may have a restriction on the method of audio output. If “D.MIX” does not appear in the display when playing multi-channel DVD-Audio, only audio for the two front channels will be output. Refer to the disc’s jacket. <b>DVD-A</b></li> </ul>	7–9, 49 17, 26 31 —	
	Cannot switch audio.	<ul style="list-style-type: none"> <li>• You cannot switch the audio in the following cases.                             <ul style="list-style-type: none"> <li>– When a DVD-R disc is in the disc tray while DVD drive is selected.</li> <li>– When the recording mode is XP and “Audio for XP Recording” is set to “LPCM”.</li> <li>– When “DVD-R High-Speed Recording” is set to “On”</li> </ul> </li> <li>• You have used digital connection. Set “Dolby Digital” to “PCM” or connect using audio cables (analog connection).</li> <li>• There are discs for which audio cannot be changed because of how the disc was created.</li> </ul>	— — 49 48 49, 9 —

Operation		
Cannot operate the television. The remote control doesn't work.	<ul style="list-style-type: none"> <li>• Change manufacturer code. Some televisions cannot be operated even if you change the code.</li> <li>• The remote control and main unit are using different codes. Change the code on the remote control.</li> </ul>	12 13
	 <p>Press and hold [ENTER] and the indicated number button at the same time for more than 2 seconds.</p>	
	<ul style="list-style-type: none"> <li>• The batteries are depleted. Replace them with new ones.</li> <li>• Colored glass may obstruct the signal reception/transmission.</li> <li>• Don't place the signal sensor in direct sunlight or in areas that may be subject to sunlight exposure.</li> </ul>	4 — —
	<ul style="list-style-type: none"> <li>• Recording drive or playback drive has not been selected properly.</li> <li>• Some operations may be prohibited by the disc.</li> <li>• The unit is hot (“U14” appears on the display). Wait for “U14” to disappear.</li> <li>• One of the unit’s safety devices may have been activated.</li> </ul> <p>Reset the unit as follows: Press [POWER ⏻/⏪] on the main unit to switch the unit to standby. If the unit doesn't switch to standby, press and hold [POWER ⏻/⏪] on the main unit for about 10 seconds. The unit is forcibly switched to standby. Alternatively, disconnect the AC power supply cord, wait one minute, then reconnect it.</p>	16, 24 — — —
HDD activation is slow.	<ul style="list-style-type: none"> <li>• The HDD is in SLEEP mode. (“HDD SLP” appears in the unit’s display.)</li> </ul>	62
Cannot eject disc.	<ul style="list-style-type: none"> <li>• The unit may have a problem. While the unit is off, press and hold [■] and [CH ^] on the main unit at the same time for about 5 seconds. Remove the disc and consult the dealer.</li> </ul>	—

Recording/Timer recording/Transferring (dubbing)			
Cannot record.	<ul style="list-style-type: none"> <li>• You haven't inserted a disc or the disc you inserted cannot be recorded on. Insert a disc the unit can record onto.</li> <li>• The disc is unformatted. Format the disc. <b>RAM</b></li> <li>• The write-protect tab on the cartridge is set to PROTECT, or the disc is protected with DISC SETTING.</li> <li>• Some programs have limitations on the number of times they can be recorded. (CPRM)</li> <li>• You cannot record when there is not enough space or when the number of titles has reached its limit. Erase unwanted titles.</li> <li>• You cannot record on finalized DVD-R discs.</li> <li>• Due to peculiarities of DVD-R, you may be unable to record onto them if you either insert and remove the disc or switch the unit on and off while a disc is loaded, a total of fifty times.</li> <li>• A DVD-R recorded on this unit may not be recordable on other Panasonic DVD recorders.</li> </ul>	14 45 44 53 26, 33, 44, 45 — — —	
	<ul style="list-style-type: none"> <li>• The timer program is incorrect or different timer program times overlap. Correct the program.</li> <li>• Timer recording program may be deleted if there is an interruption to the power.</li> <li>• VCR Plus+ system works only after this unit downloads the television program list.</li> </ul>	21 — —	
	VCR Plus+ system does not work properly.		
	Timer recording does not stop even when [■] is pressed.	<ul style="list-style-type: none"> <li>• Press [■] and then [ENTER] within 5 seconds. Recording stops.</li> </ul>	19, 20, 21
	The timer program remains even after recording finishes.	<ul style="list-style-type: none"> <li>• The timer program remains unless set to “Once”.</li> </ul>	19, 20
	A part or whole of a recorded title has been lost.	<ul style="list-style-type: none"> <li>• If there is a power failure or the plug is disconnected from the household AC outlet while recording or editing, the title may be lost or the HDD/disc may become unusable. You will have to format the disc (<b>HDD RAM</b>) or use a new disc. We cannot offer any guarantee regarding lost titles or discs.</li> </ul>	45

Continued on next page

**Recording/Timer recording/Transferring (dubbing) (Continued)**

**Page**

<p><b>Cannot transfer (dub) to a DVD-R disc using the high speed mode.</b></p>	<ul style="list-style-type: none"> <li>•When recording to the HDD, set “DVD-R High-Speed Recording” to “On” in the SETUP menu.</li> </ul>	<p><b>48</b></p>
<p><b>When transferring (dubbing), it takes a long time even when high speed mode is selected.</b></p>	<ul style="list-style-type: none"> <li>•Use a disc that is compatible with high speed recording. Even if the disc is high speed recording compatible, the maximum speed recording rating may not be possible due to the condition of the disc.</li> <li>•It takes longer than normal to transfer (dub) many titles.</li> <li>•You cannot high speed transfer (dub) to DVD-R titles longer than 6 hours when using other Panasonic DVD recorders that are not compatible with EP (8 hour) mode recording.</li> </ul>	<p>— — —</p>
<p><b>An unusually loud sound coming from the rotating DVD-R.</b></p>	<ul style="list-style-type: none"> <li>•When recording or high speed transferring (dubbing) to a DVD-R, the sound of the disc rotating may be louder than normal; however, this is not a problem.</li> </ul>	<p>—</p>
<p><b>The DV automatic recording function does not work.</b></p>	<ul style="list-style-type: none"> <li>•If images cannot be recorded or if the recording is aborted, check the connections and DV equipment settings.</li> <li>•You cannot start recording until the images from the DV equipment appear on the television.</li> <li>•Recording may not be performed as desired if the time codes on the tape in the DV equipment are not successive.</li> <li>•Depending on the equipment, the DV automatic recording may not operate properly.</li> </ul>	<p><b>41</b> — — —</p>

**TV Guide On Screen™ system**

<p><b>Although initial setup for the TV Guide On Screen™ system was completed hours ago, television program list does not display when [TV GUIDE] is pressed.</b></p>	<ul style="list-style-type: none"> <li>•Leave the unit turned off for at least 24 hours.</li> <li>•Initial setup was done incorrectly. (e.g. The user entered the wrong country, ZIP/postal code or cable TV box information.) Select “Change system settings” menu and verify the data entered during initial setup. If the settings are wrong, set up the TV Guide On Screen™ system again.</li> <li>•Check the connection and set up the TV Guide On Screen™ system again.                     <ul style="list-style-type: none"> <li>If you connect a cable TV box                             <ul style="list-style-type: none"> <li>–the output terminal of the cable TV box is connected to this unit’s RF IN or IN3 (L3) terminal</li> <li>–the IR Blaster is correctly connected and installed</li> <li>–the cable TV box is turned on</li> </ul> </li> <li>If you do not connect a cable TV box                             <ul style="list-style-type: none"> <li>–the antenna cable is connected to this unit’s RF IN terminal</li> </ul> </li> </ul> </li> <li>•The television program list was temporarily unavailable in your area (Wait another 24 hours or Re-do setup).</li> <li>•The television program list is not available in your area. Set the unit using “Auto Channel Setting”. Note that you can only manually set timer recording after you set the unit using “Auto Channel Setting”.</li> <li>•Consult your service provider if you are using a cable TV box.</li> </ul>	<p>— <b>23</b>  <b>23</b> <b>8</b> <b>8</b> — <b>7</b> — <b>50</b> —</p>
<p><b>“Cable code -INCOMPLETE-” appears in the TV Guide On Screen™ system setup.</b></p>	<ul style="list-style-type: none"> <li>•The unit cannot find the correct IR code for the cable TV box. Consult your service provider.</li> </ul>	<p>—</p>
<p><b>As soon as the unit is turned on, and when you try to start timer recording, the TV Guide On Screen™ system setup begins.</b></p>	<ul style="list-style-type: none"> <li>•Even if you do not want to use the TV Guide On Screen™ system, you need to complete the TV Guide On Screen™ system setup (until you have to press [ENTER] after the “Watch TV” message screen is displayed). It will not be displayed after this point.</li> </ul>	<p><b>10</b></p>
<p><b>Some or all of the channels display “No Listing”</b></p>	<ul style="list-style-type: none"> <li>•For a newly installed unit, the TV Guide On Screen™ system may have not been given enough time to download the initial data. This procedure can only occur when the unit is in standby mode for a period of 24 hours. (During this time, do not turn on the unit as the download will be interrupted.) Once the procedure takes place the phrase “No Listings” will be replaced with program information.</li> <li>•The channel(s) in question was (were) recently turned “ON” (in the CHANNEL EDITOR screen) and TV Guide On Screen™ system has yet to receive channel data for this channel. Leave the unit in standby mode.</li> <li>•Immediately after beginning use there are several days of blank listings. You can display the television program list for up to the next 8 days forward without any blank listings by downloading program lists continuously over several days.</li> <li>•The unit was left turned on for an extended period of time and the TV Guide On Screen™ system was unable to receive television program list data. Press [⏻ DVD POWER] to set the unit in standby mode when not in use.</li> <li>•During the data download the station from which data is downloaded had an unscheduled power outage.</li> <li>•If using an off-air antenna, marginally poor reception can cause some of the data to be missed.</li> <li>•If using a cable TV box, it was accidentally turned off. In installations using a cable TV box, the box must be left on continuously.</li> </ul>	<p>— — — — — — — — — —</p>

Continued on next page

TV Guide On Screen™ system (Continued)

Page

<p>Cannot receive some channels displayed on the television program list.</p>	<ul style="list-style-type: none"> <li>•Cable TV subscribers receive channel data for all available channels your cable TV provider offers. In order to view all the channels, you'd also have to subscribe to all the channels. If you are connected to an off-air antenna the channel data you receive often represents a viewing area larger than you would typically be able to receive. Your location, the type of TV antenna you are using and your distance from each station's transmitting antenna will all determine which channels are viewable from your location. Once you've determined which channels can be received, all others can be removed from the television program list. Set these channels to "OFF" in the CHANNEL EDITOR screen.</li> </ul>	<p>23</p>
<p>Some of off-air or cable channels are not listed on the television program list and even on the CHANNEL EDITOR screen.</p>	<ul style="list-style-type: none"> <li>•Presently, the TV Guide On Screen™ system does not list all channels in any given broadcast area. As a result, channels are selected primarily on a "majority rules" basis. Channels with the highest potential viewership are given top priority.</li> <li>•Data for local programming which is not provided to TV Guide's data distribution network would also not be available.</li> </ul>	<p>—</p>
<p>The program highlighted doesn't match up with the video window on the TV screen.</p>	<ul style="list-style-type: none"> <li>•The data entered during the initial setup was incorrect or the channel line-up you selected was incorrect. Select "Change system settings" menu and verify the data entered during initial setup. If the settings are wrong, set up the TV Guide On Screen™ system again.</li> <li>•The station in question may have made recent program schedule changes and the TV Guide On Screen™ system has not yet been updated.</li> </ul>	<p>23</p>
<p>The unit doesn't change channels or it changes to the wrong channel.</p>	<ul style="list-style-type: none"> <li>•Data entered into the initial setup screen was done incorrectly. (e.g. The user entered the wrong ZIP/postal code or selected the incorrect channel line-up.) Select "Change system settings" menu and verify the data entered during initial setup. If the settings are wrong, set up the TV Guide On Screen™ system again.</li> </ul>	<p>23</p>
<p>Some of channels are listed on the wrong number.</p>	<ul style="list-style-type: none"> <li>•The cable company has not yet informed industry sources of their channel line-up changes. Use the CHANNEL EDITOR feature to make adjustments.</li> </ul>	<p>23</p>
<p>Two stations are received on certain channels; morning and evening programs differ.</p>	<ul style="list-style-type: none"> <li>•Such situations occur more frequently on cable TV. "Split" channels occur when the cable provider may not have an adequate number of open channels and chooses to switch the channel line to better suit the subscribers viewing habits. When a "Split" channel occurs, program data for only one channel is usually provided.</li> </ul>	<p>—</p>
<p>Cable TV box doesn't change channels with TV Guide On Screen™ system.</p>	<ul style="list-style-type: none"> <li>•The incorrect cable TV box brand code was selected during the initial setup. Select "Change system settings" menu and verify the data entered during initial setup. If the setting is wrong, set up the TV Guide On Screen™ system again.</li> <li>•The user has incorrectly connected or positioned the IR Blaster. Please reconnect or reposition it.</li> <li>•The cable TV box has no remote capability and is incompatible. Consult your service provider.</li> <li>•The user has an "after market" brand cable TV box which may be incompatible. Consult your service provider.</li> </ul>	<p>23</p>
<p>Cannot record a program. The screen remains snowy or blue.</p>	<p>If you do not connect a cable TV box</p> <ul style="list-style-type: none"> <li>•The unit was not hooked up correctly. Please reconnect it.</li> <li>•The user selected the incorrect channel lineup. Select "Change system settings" menu and verify the data entered during initial setup. If the setting is wrong, set up the TV Guide On Screen™ system again.</li> </ul> <p>If you connect a cable TV box</p> <ul style="list-style-type: none"> <li>•The unit is not set to the correct output channel. Select "Change system settings" menu and verify the data entered during initial setup. If the setting is wrong, redo setup correctly choosing 03, 04 or whichever output channel is set by your cable system.</li> <li>•The unit and/or cable TV box is hooked up incorrectly. Please reconnect it, or contact the cable company for proper wiring procedure.</li> <li>•The cable TV box was left OFF. The user should always leave the cable TV box turned on and the unit turned off (when not in use).</li> </ul>	<p>7</p> <p>23</p>
<p>The SCHEDULE screen only shows the channel number of the program instead of the program name.</p>	<ul style="list-style-type: none"> <li>•The time slot and channel for the scheduled program may have not yet received listings information. Once updated information is received the program name will appear in the SCHEDULE screen.</li> </ul>	<p>—</p>

Play

<p>Play fails to start even when [▶] (PLAY) is pressed. Play starts but then stops immediately.</p>	<ul style="list-style-type: none"> <li>•Insert the disc correctly with the label facing up.</li> <li>•You tried to play a blank DVD-RAM/DVD-R, or disc unplayable on this unit.</li> <li>•You may be able to transfer (dub) a "One time only recording" title that was recorded to DVD-RAM using a different Panasonic DVD Recorder to this unit's HDD, but play is not possible due to copyright protection.</li> <li>•When recording to DVD-RAM using EP (8H) mode, play may not be possible on DVD players that are compatible with DVD-RAM. In this case use EP (6H) mode.</li> <li>•You cannot play discs during DV automatic recording.</li> </ul>	<p>24</p> <p>14</p> <p>—</p> <p>48</p>
<p>Audio and video momentarily pause.</p>	<ul style="list-style-type: none"> <li>•This occurs between play list chapters.</li> <li>•This occurs between chapters and with partially deleted titles on finalized DVD-R that have been transferred (dubbed) using the high speed mode.</li> </ul>	<p>—</p> <p>—</p>
<p>DVD-Video is not played.</p>	<ul style="list-style-type: none"> <li>•Some DVD-Video cannot be played when you change the ratings level.</li> </ul>	<p>48</p>

Play (Continued)

Page

<b>Alternative soundtrack and subtitles cannot be selected.</b>	<ul style="list-style-type: none"> <li>•The languages are not recorded on the disc.</li> <li>•You may have to use the disc's menus to select languages.</li> </ul>	— —
<b>No subtitles.</b>	<ul style="list-style-type: none"> <li>•When progressive output is on, closed captions cannot be displayed.</li> <li>•Subtitles are not recorded on the disc.</li> <li>•Turn the subtitles on.</li> </ul>	— — <b>30</b>
<b>Angle cannot be changed.</b>	<ul style="list-style-type: none"> <li>•Angles can only be changed during scenes where different angles are recorded.</li> </ul>	—
<b>You have forgotten your ratings password.</b>	<ul style="list-style-type: none"> <li>•While the disc tray is open, press [DVD] then press and hold [◀◀/▶▶] and [▶▶/▶▶] on the main unit at the same time for 5 or more seconds ("INIT" will appear on the unit's display).</li> </ul>	—
<b>Quick View does not work.</b>	<ul style="list-style-type: none"> <li>•This does not work if the setting is "Off" in "Search Audio &amp; PLAY ×1.3".</li> <li>•This does not work when audio is other than Dolby Digital.</li> <li>•This does not work when recording is in XP or FR mode. <b>RAM</b></li> </ul>	<b>48</b> — —
<b>The resume play function does not work.</b>	<ul style="list-style-type: none"> <li>•This function only works when "PLAY" is flashing on the unit display.</li> <li>•Memorized positions are canceled when the unit is turned off or when the tray is opened. The memorized position on the play list is also canceled when the play list and title are edited.</li> </ul>	— —

Edit

<b>Cannot format.</b>	<ul style="list-style-type: none"> <li>•The disc is dirty. Use a special cleaner and wipe clean.</li> <li>•You tried formatting a disc that is not compatible with this unit.</li> </ul>	<b>62</b> <b>14</b>
<b>Cannot create chapters.</b>	<ul style="list-style-type: none"> <li>•The unit writes the chapter division information to the disc when you turn it off or remove the disc. The information is not written if there is an interruption to the power before this.</li> </ul>	—
<b>Cannot mark the start point or the end point during "Shorten" operation.</b>	<ul style="list-style-type: none"> <li>•These operations are not possible with still pictures.</li> <li>•You cannot set points if they are too close to each other. You cannot set an end point before a start point.</li> </ul>	— —
<b>Cannot erase chapters.</b>	<ul style="list-style-type: none"> <li>•When the chapter is too short to erase, use "Combine Chapters" to make the chapter longer.</li> </ul>	<b>33</b>
<b>The available recording time doesn't increase even after erasing recordings on the disc.</b>	<ul style="list-style-type: none"> <li>•Available recording space on the DVD-R does not increase even after erasing previously recorded titles.</li> </ul>	—
<b>Cannot create a play list.</b>	<ul style="list-style-type: none"> <li>•You cannot select all the chapters at once in a title if the title also includes still pictures. Select them individually.</li> </ul>	—

Still pictures

<b>Cannot display Direct Navigator screen.</b>	<ul style="list-style-type: none"> <li>•This screen cannot be displayed during recording or transfer (dubbing) or while the unit is standing by for linked timer recording with external equipment.</li> </ul>	—
<b>Cannot edit or format a card.</b>	<ul style="list-style-type: none"> <li>•Release the card's protection setting. (With some cards, the "WRITE PROTECTION OFF" message sometimes appears on the screen even when protection has been set.)</li> </ul>	<b>44</b>
<b>The contents of the card cannot be read.</b>	<ul style="list-style-type: none"> <li>•The card format is not compatible with the unit. (The contents on the card may be damaged.) Format using FAT 12 or FAT 16 with other equipment or format the card with this unit.</li> <li>•The card contains a folder structure and/or file extensions that are not compatible with this unit.</li> <li>•Turn off and then turn on the unit again.</li> </ul>	<b>15, 28</b> <b>45</b> <b>15</b> —
<b>Transferring (dubbing), erasing and setting protection takes a long time.</b>	<ul style="list-style-type: none"> <li>•When there are a lot of folders and files, it may sometimes take a few hours.</li> <li>•When repeating transferring (dubbing) or erasing, it may sometimes take a long time. Format the disc or card.</li> </ul>	— <b>45</b>
<b>The PC card cannot be removed.</b>	<ul style="list-style-type: none"> <li>•Make sure the PC card is slotted home firmly before attempting to remove.</li> </ul>	<b>28</b>
<b>Timer recording began in the middle of editing a still picture.</b>	<ul style="list-style-type: none"> <li>•If it comes to the time scheduled for timer recording, the recording may start even though you are editing.</li> </ul>	—

## Product Service

- 1. Damage requiring service**—The unit should be serviced by qualified service personnel if:
  - (a) The AC power supply cord or AC adaptor has been damaged; or
  - (b) Objects or liquids have gotten into the unit; or
  - (c) The unit has been exposed to rain; or
  - (d) The unit does not operate normally or exhibits a marked change in performance; or
  - (e) The unit has been dropped or the cabinet damaged.
- 2. Servicing**—Do not attempt to service the unit beyond that described in these operating instructions. Refer all other servicing to authorized servicing personnel.
- 3. Replacement parts**—When parts need replacing ensure the servicer uses parts specified by the manufacturer or parts that have the same characteristics as the original parts. Unauthorized substitutes may result in fire, electric shock, or other hazards.
- 4. Safety check**—After repairs or service, ask the servicer to perform safety checks to confirm that the unit is in proper working condition.

## Unit care

The precision parts in this unit are readily affected by the environment, especially temperature, humidity, and dust. Cigarette smoke also can cause malfunction or breakdown.

To clean this unit, wipe with a soft, dry cloth.

- Never use alcohol, paint thinner or benzine to clean this unit.
- Before using chemically treated cloth, read the instructions that came with the cloth carefully.

Observe the following points to ensure continued listening and viewing pleasure.

Dust and dirt may adhere to the unit's lens over time, making it impossible to record or play discs.

Use the DVD-RAM/PD lens cleaner (LF-K123LCA1, where available) about once every year, depending on frequency of use and the operating environment. Read the lens cleaner's instructions carefully before use.

## Disc and card handling

### How to hold a disc or card

Do not touch the recorded surface or the terminal surface.



### If there is dirt or condensation on the disc

#### RAM DVD-R

- Clean with an optional DVD-RAM/PD disc cleaner (LF-K200DCA1, where available).
- Do not use cleaners for CDs or cloths.

#### DVD-A DVD-V VCD CD

Wipe with a damp cloth and then wipe dry.



### Handling precautions

- Do not attach labels or stickers to discs. (This may cause disc warping and un-balanced rotation, rendering it unusable.)
- Do not write on the label side with a ball-point pen or other writing instrument.
- Do not use record cleaning sprays, benzine, thinner, static electricity prevention liquids or any other solvent.
- Do not use scratch-proof protectors or covers.
- Do not expose the terminals of the card to water, garbage or other strange things.
- Do not use the following discs:
  - Discs with exposed adhesive from removed stickers or labels (rented discs, etc).
  - Discs that are badly warped or cracked.
  - Irregularly shaped discs, such as heart shapes.
- Do not place in the following areas:
  - In direct sunlight.
  - In very dusty or humid areas.
  - Near a heater.
  - Where static electricity or electromagnetic waves occur



## HDD (Hard disk drive) handling care

The HDD is a high precision recording instrument and because of its long recording capability and high speed operation it is a very special device that is easily susceptible to damage.

As a basic rule, save important video content to a DVD disc as backup.

### The HDD is a device that is not built to withstand vibration/shock or dust

Depending on the setup environment and handling of the HDD some content may become damaged and play and recording may no longer be possible. Especially during operation, do not subject the unit to any vibration, shock, or remove the AC power plug from the household AC outlet. In the event of a power failure the content, during recording or play, may be damaged.

### The HDD is a temporary storage device

The HDD is not an everlasting storage device for recorded content. Use the HDD as a temporary storage place for viewing once, editing, or for saving to a DVD disc.

### Immediately save (backup) all content as soon as you feel there may be problem with the HDD

If there is an irregularity within the HDD, strange sounds or problems with picture (block noise, etc.) may result. Using the HDD in this condition may worsen the problem and in the worst case the HDD

may no longer become usable. As soon as you notice this type of problem, save all content to the DVD disc.

Recorded content (data) on an HDD that has become unusable is unrecoverable.

### Setup precautions

- Do not place in an enclosed area so the rear cooling fan and the cooling vents on the side are covered up.
- Place the unit on a surface that is flat and not subject to vibration or impact.

- Do not place on anything that generates heat like a video cassette recorder, etc.



- Do not place in an area often subject to temperature changes.
- Do not place in an area where condensation does not occur. Condensation is a phenomenon where moisture forms on a cold surface when there is an extreme change in temperature. Condensation may cause internal damage to the unit.

### Conditions where condensation may occur

- When there is an extreme change in temperature (moving from a very hot location to a very cold location, or vice versa, or when subjected to an air conditioner or when cooled air directly impacts the unit.) When the HDD (warms during operation) is subjected to cold air, condensation may form on the inside of the HDD and may cause damage to the HDD heads, etc.
- When there is high humidity or a lot of steam in the room.
- During the rainy season.

- In the above situation, **without turning the unit on**, let the unit adjust to the room temperature and wait 2–3 hours until condensation is gone.

### Cigarette smoke, etc. causes malfunction or breakdown

The unit may breakdown if cigarette smoke or bug spray/vapor, etc. gets inside the unit.

### While operating

- Do not move the unit or subject to vibration or impact. (The HDD may become damaged.)
- Do not remove the AC power plug from the household AC outlet, or flip the power breaker switch.

While the unit is on, the HDD is rotating at high speed. Sound or movement due to rotation is normal.

### When moving the unit

- ① Turn the unit off. (Wait until "BYE" disappears from the display.)
- ② Remove the AC power plug from the household AC outlet.
- ③ Move only after the unit has come to a complete stop (approx. 2 minutes) in order to avoid subjecting to vibration and shock. (Even after turning the unit off, the HDD continues operating for a short time.)

### HDD recording time remaining

This unit records using a VBR (Variable bit rate) data compression system to vary recorded data segments to match video data segments which may cause differences in the displayed amount of time and space remaining for recording.

If the remaining amount of time is insufficient, erase any unwanted titles to create enough space before you start recording. (Erasing a play list will not increase the amount of time.)

### When "HDD SLP (SLEEP)" appears in the display

The HDD has been automatically placed in the SLEEP mode. (The HDD continues to rotate at high speed while the unit is on. In order to extend the life of the HDD, the HDD will be placed in the SLEEP mode if no operation has been performed for 30 minutes while there is no disc on the disc tray.)

- Press [HDD] to activate.
- While in SLEEP mode play or recording may not begin right away because the HDD takes time to be re-activated.
- When not using the unit, we recommend removing the disc in the tray in order to set the HDD to the SLEEP mode.

### Indemnity concerning recorded content

Panasonic does not accept any responsibility for damages directly or indirectly due to any type of problems that result in loss of recording or edited content (data), and does not guarantee any content if recording or editing does not work properly. Likewise, the above also applies in a case where any type of repair is made to the unit (including any other non-HDD related component).

# Limited Warranty

## Panasonic Broadcast & Television Systems Company, Unit company of Matsushita Electric Corporation of America

One Panasonic Way  
Secaucus, NJ 07094

## Panasonic Sales Company, Division of Matsushita Electric of Puerto Rico, Inc.

Ave. 65 de Infantería, Km.9.5  
San Gabriel Industrial Park  
Carolina, Puerto Rico 00985

### PANASONIC DVD RECORDER Limited Warranty

Panasonic Broadcast & Television Systems Company or Panasonic Sales Company (collectively referred to as "the Warrantor") will repair this product and all included accessories with new or refurbished parts, free of charge in the USA or Puerto Rico, from the date of the original purchase in the event of a defect in materials or workmanship as follows:

**Parts**—New or rebuilt parts in exchange for defective parts for one (1) year from the date of original purchase.

**Labor**—Carry-in or mail-in service for one (1) year from the date of original purchase.

**Batteries**—(If included) New rechargeable batteries in exchange for defective rechargeable batteries for ten (10) days from the date of original purchase. Non-rechargeable batteries are not warranted.

**4.7 DVD-RAM Disc**—(If included) New 4.7 DVD-RAM Disc in exchange for defective disc for ten (10) days from the date of original purchase.

Carry-in or mail-in service in the USA may be obtained during the warranty period by contacting Panasonic Broadcast & Television Systems Company Factory Servicenter listed in the Service Directory or call toll free 1-800-526-6610 to locate an authorized Servicenter.

Carry-in or mail-in service in Puerto Rico can be obtained during the warranty period by calling local service center at 787-750-5135.

This warranty is extended only to the original purchaser. A purchase receipt or other proof of date of original purchase will be required before warranty service is rendered.

This warranty only covers failures due to defects in materials or workmanship, which occur during normal use. The warranty does not cover damage which occurs in shipment, or failures which are caused by products not supplied by the warrantor, or failures which result from accident, misuse, abuse, neglect, mishandling, misapplication, alteration, modification, faulty installation, set-up adjustments, improper antenna, inadequate signal pickup, maladjustment of consumer controls, improper operation, power line surge, improper voltage supply, lightning damage, or service by anyone other than a DVD Recorder authorized repair facility, or damage that is attributable to acts of God.

#### LIMITS AND EXCLUSIONS

There are no express warranties except as listed above.

THE WARRANTOR SHALL NOT BE LIABLE FOR INCIDENTAL OR CONSEQUENTIAL DAMAGES (INCLUDING, WITHOUT LIMITATION, DAMAGE TO DISCS) RESULTING FROM THE USE OF THIS PRODUCT, OR ARISING OUT OF ANY BREACH OF THE WARRANTY. ALL EXPRESS AND IMPLIED WARRANTIES, INCLUDING THE WARRANTIES OF MERCHANTABILITY AND FITNESS FOR PARTICULAR PURPOSE, ARE LIMITED TO THE APPLICABLE WARRANTY PERIOD SET FORTH ABOVE.

Some states do not allow the exclusion or limitation of incidental or consequential damages, or limitations on how long an implied warranty lasts, so the above exclusions or limitations may not apply to you.

This warranty gives you specific legal rights and you may also have other rights, which vary from state to state.

***If you have a problem with this product that is not handled to your satisfaction, then write the Consumer Affairs Department at the Company address indicated above.***

#### Regional Service Offices

##### Central

1707 N. Randall Rd.  
Elgin, IL 60123  
847-468-5254

##### Southern

1225 Northbrook Pkwy  
Suite 170  
Suwanee, GA 30024  
770-338-6858

##### Northeast

50 Meadowsland Pkwy  
Secaucus, NJ 07094  
201-348-7975

##### Western

3330 Cahuenga Blvd. West  
Los Angeles, CA 90068  
323-436-3507

<b>Angle</b> .....	30	<b>Erase</b>		<b>Protection</b>	
<b>Antenna system</b> .....	47	All titles .....	44	Card .....	44
<b>Audio</b>		Chapter .....	26, 33, 35	Cartridge .....	44
Attribute .....	30	Folder .....	36	Disc .....	44
Language .....	47	Play list .....	26, 35	Folder .....	36
Playback .....	26	Still picture .....	36	Still picture .....	36
Receiving, recording .....	17	Title .....	26, 33	Title .....	33
<b>Change Thumbnail</b> .....	33	<b>Favorite</b> .....	22	<b>Quick View</b> .....	25
<b>Channel</b>		<b>Finalize</b> .....	45, 53	<b>Ratings level</b> .....	48
Adjusting, hiding .....	23	<b>Flexible Recording</b> .....	18	<b>Recording</b>	
Audio .....	30	<b>Format</b> .....	45, 53	DV automatic recording .....	41
Auto Channel Setting .....	50	<b>FR (Flexible Recording Mode)</b> .....	17	Flexible Recording .....	18
Captions .....	51	<b>FUNCTIONS window</b> .....	43	Mode .....	17
CHANNEL EDITOR .....	23	<b>JPEG</b> .....	28, 53	Relief .....	21
<b>Chapter</b> .....	26, 32	<b>Language</b>		Timer .....	19–21
<b>Chasing playback</b> .....	18	Audio .....	47	<b>Re-initialize settings</b> .....	47
<b>Cleaning</b>		Code list .....	55	<b>Relief Recording</b> .....	21
Disc .....	62	On-screen .....	49	<b>Remote control code</b> .....	13
Lens .....	62	Sound track .....	30	<b>Repeat play</b> .....	31
Main unit .....	62	Subtitle .....	30, 47	<b>Resume play function</b> .....	25
<b>Clock setting</b> .....	11, 50	<b>LPCM</b> .....	49, 53	<b>SD card</b> .....	15
<b>CM Skip</b> .....	25	<b>Menu</b>		<b>SETUP menu</b> .....	47
<b>Connection</b>		MP3 .....	27	<b>Shorten (titles)</b> .....	33
Amplifier, system component .....	9	On-screen .....	30	<b>Simultaneous rec and play</b> .....	18
Antenna .....	7, 8, 9	SETUP .....	47	<b>Sound track</b> .....	30
Cable TV box .....	8	<b>Mode</b>		<b>Status messages</b> .....	31
DV input terminal .....	41	Recording .....	17	<b>Still pictures</b>	
IR Blaster .....	8	Still Mode .....	48	Edit .....	36
L2 input terminals .....	41	<b>MPEG-DNR</b> .....	31	Play .....	28
Television .....	7	<b>MP3</b> .....	27	Transferring (dubbing) .....	42
Video cassette recorder .....	7, 8, 41	<b>Noise reduction (NR)</b>		<b>Subtitle</b> .....	30
<b>Copy (play list)</b> .....	35	Integrated DNR .....	31	<b>TIFF</b> .....	28, 53
<b>CPRM</b> .....	53	MPEG-DNR .....	31	<b>Time Slip</b> .....	18, 25
<b>Create play lists</b> .....	34	Line-in NR .....	48	<b>Timer recording</b> .....	19–21
<b>Dialog Enhancer</b> .....	31	3D NR .....	31	<b>Transfer</b> .....	31
<b>Direct Navigator</b> .....	24, 29, 32, 36	<b>One Touch Transfer (dubbing)</b> .....	38	<b>Transfer (dubbing)</b>	
<b>Divide Chapter</b> .....	33	<b>On-screen</b>		List .....	38
<b>Divide Title</b> .....	33	Language .....	49	One Touch Transfer (dubbing) .....	38
<b>DPOF</b> .....	36, 53	Menus .....	30	Still picture .....	42
<b>DV automatic recording</b> .....	41	Status messages .....	31	<b>TV Guide On Screen™</b> .....	19, 22
<b>DVD-R (Enabling DVD-R to be played on other equipment—Finalize)</b> .....	45	<b>PC card</b> .....	15	<b>TV Type</b> .....	12
<b>DVD-R High-Speed Recording</b> .....	48	<b>PCM Down Conversion</b> .....	49	<b>VCR Plus+</b> .....	20
<b>DVD-RAM, DVD-R</b> .....	14	<b>Picture</b> .....	31	<b>V.S.S.</b> .....	31
<b>Enter name</b>		<b>Play list</b> .....	34		
Disc .....	44	<b>Progressive</b> .....	31, 53		
Entering text .....	46	<b>Properties</b>			
Folder .....	36	Play list .....	35		
Play list .....	35	Still picture .....	29		
Title .....	33	Title .....	33		

Manufactured under license from Dolby Laboratories.  
“Dolby” and the double-D symbol are trademarks of Dolby Laboratories.

“DTS” and “DTS 2.0 + Digital Out” are trademarks of Digital Theater Systems, Inc.

U.S. patent Nos. 4,631,603, 4,577,216, 4,819,098, and 4,907,093.

MPEG Layer-3 audio decoding technology licensed from Fraunhofer IIS and Thomson multimedia.

This product incorporates copyright protection technology that is protected by U.S. patents and other intellectual property rights. Use of this copyright protection technology must be authorized by Macrovision, and is intended for home and other limited consumer uses only unless otherwise authorized by Macrovision. Reverse engineering or disassembly is prohibited.

●SD logo is a trademark.

●Portions of this product are protected under copyright law and are provided under license by ARIS/SOLANA/4C.

**Panasonic Broadcast & Television Systems Company,**  
Unit company of Matsushita Electric Corporation of America  
One Panasonic Way  
Secaucus, NJ 07094

**Panasonic Sales Company,**  
Division of Matsushita Electric of Puerto Rico, Inc. (“PSC”)  
Ave. 65 de Infantería, Km. 9.5  
San Gabriel Industrial Park, Carolina,  
Puerto Rico 00985

En